

# MDS TransNET 900™ MDS TransNET 2400™



## Spread Spectrum Data Transceiver

*Including supplemental data for Board-Only units*

MDS 05-2708A01, Rev. F

MARCH 2013



Digital Energy  
MDS

Reference Manual

*Quick-Start instructions for this product are contained  
in publication 05-4481A01.*

*All GE MDS manuals are available online at  
**[www.gemds.com](http://www.gemds.com)***

---

# CONTENTS

---

1.0 ABOUT THIS MANUAL .....	1
2.0 PRODUCT DESCRIPTION .....	1
2.1 Transceiver Features .....	1
2.2 Model Number Codes .....	2
2.3 Spread Spectrum Radios—How Are They Different? .....	2
2.4 Typical Applications .....	2
Multiple Address Systems (MAS) .....	2
Point-to-Point System .....	3
Adding a Tail-End Link to an Existing Network .....	3
Extending a TransNET Network with a Repeater .....	4
2.5 Accessories .....	5
3.0 INSTALLATION PLANNING .....	6
3.1 General Requirements .....	6
3.2 Site Selection .....	6
Terrain and Signal Strength .....	7
Conducting a Site Survey .....	7
3.3 A Word About Radio Interference .....	8
3.4 Antenna & Feedline Selection .....	9
Antennas .....	9
Feedlines .....	10
Antenna System Ground .....	11
3.5 How Much Output Power Can be Used? .....	12
4.0 INSTALLATION .....	14
4.1 Transceiver Installation .....	14
4.2 Configuring Multiple Remote Units .....	18
4.3 Tail-End Links .....	18
4.4 Configuring a Network for Extensions .....	19
5.0 OPERATION .....	19

---



5.1	Initial Start-up .....	19
5.2	Performance Optimization .....	20
	Antenna Aiming.....	20
	Antenna SWR Check.....	21
	Data Buffer Setting—Modbus Protocol .....	21
	Hoptime Setting .....	21
	TotalFlow™ Protocol at 9600 with Sleep Mode .....	21
	Operation at 115200 bps.....	21
	Baud Rate Setting.....	22
	Radio Interference Checks .....	22
<b>6.0</b>	<b>RADIO PROGRAMMING .....</b>	<b>22</b>
<hr/>		
6.1	Radio Programming Methods .....	22
	Terminal Interface .....	22
	PC-Based Configuration Tool.....	22
6.2	User Commands .....	23
	Entering Commands .....	23
6.3	Detailed Command Descriptions .....	28
	ADDR [1–65000].....	29
	<i>Network Address</i>	
	AMASK [0000 0000–FFFF FFFF].....	29
	<i>Alarm Mask</i>	
	AT [ON, OFF].....	29
	<i>Hayes-Compatible AT Command Support</i>	
	ASENSE [HI/LO].....	29
	<i>Alarm Output Sense</i>	
	BAUD [xxxxx abc] .....	29
	<i>Data Interface Port Baud Rate</i>	
	BAND [A, B, C].....	30
	<i>Select Sub-Band (Normally used for 2.4 GHz units)</i>	
	BUFF [ON, OFF].....	30
	<i>Data Buffer Mode</i>	
	CODE [NONE, 1...255].....	31
	<i>Security Code</i>	
	CSADDR [1–65000, NONE] .....	31
	<i>Clock-Synchronizing Master Address</i>	
	CTS [0–255].....	31
	<i>Clear-to-Send Delay</i>	

CTSHOLD [0–60000] .....	32
<i>Clear-to-Send Hold Time</i>	
DEVICE [DCE, CTS KEY] .....	32
<i>Radio-MODEM Behavior</i>	
DLINK [xxxxx/ON/OFF] .....	32
<i>InSite Diagnostics Link Support</i>	
DKEY .....	33
<i>Turn Off Radio Transmitter’s Test Signal</i>	
DTYPE [NODE/ROOT].....	33
<i>Network Diagnostics Mode</i>	
FEC [ON, OFF].....	33
<i>Forward Error Correction</i>	
HOPTIME [7, 28] .....	34
<i>Radio Transmitter Hop Timing</i>	
INIT .....	34
<i>Initialize; Restore to Factory Defaults</i>	
HREV .....	35
<i>Hardware Revision</i>	
KEY .....	35
<i>Turn On Radio Transmitter Test Signal</i>	
LED [ON, OFF].....	36
<i>Enable/Disable PCB LEDs</i>	
LPM [1, 0].....	36
<i>Low-Power Mode—Masters Only</i>	
LPMHOLD [0–1000] .....	36
<i>Low-Power Mode Sleep Time</i>	
MODE [M, R, X].....	36
<i>Radio Operating Mode</i>	
MRSSI [NONE, –40...–90].....	37
<i>Minimum RSSI for Mobile Operation</i>	
OT [ON, OFF].....	37
<i>Output Trigger</i>	
OWM [xxxxx] .....	37
<i>“Owner’s Message”</i>	
OWN [xxxxx].....	37
<i>“Owner’s Name”</i>	
PORT [RS232, RS485].....	37
<i>Data Interface Port Signaling Standard</i>	
PWR [20–30].....	38
<i>Radio Transmitter Power Level</i>	



REPEAT [0–10].....	38
<i>Downstream Repeat Transmission Count</i>	
RETRY [0–10].....	38
<i>Upstream Repeat Transmission Count</i>	
RSSI.....	38
<i>Received Signal Strength Indicator</i>	
RTU [ON, OFF, 0-80] .....	39
<i>Remote Terminal Unit Simulator</i>	
RX [xxxx].....	39
<i>Radio Receive Test Frequency</i>	
RXD [0–255] .....	39
<i>RXD Delay</i>	
RXTOT [NONE, 0–1440] .....	40
<i>Receive Data Timeout-Timer</i>	
SAF [ON, OFF] .....	40
<i>Store-and-Forward Services Support</i>	
SETUP .....	40
<i>Setup Radio Test</i>	
SER.....	40
<i>Radio Serial Number</i>	
SHOW CON.....	41
<i>Show Virtual Connection Status</i>	
SHOW PWR .....	41
<i>Show Measured RF Transmit Power</i>	
SHOW SYNC.....	41
<i>Show Clock-Synchronization Master Ntwk Address</i>	
SKIP [NONE, 1..8] .....	41
<i>Skip Radio Operating Zones</i>	
SLEEP [ON, OFF].....	42
<i>Transceiver Sleep—Remotes Only</i>	
SREV .....	42
<i>Firmware Revision Level</i>	
STAT .....	43
<i>Alarm Status</i>	
TEMP .....	43
<i>Radio's Internal Temperature</i>	
TX [xxxx] .....	43
<i>Radio Transmit Test Frequency</i>	
UNIT [10000–65000].....	43
<i>Unit Address</i>	

XADDR [0–31].....	44
<i>Extended Address</i>	
XMAP [00000000-FFFFFFFF] .....	44
<i>Map of Extension Addresses</i>	
XPRI [0–31].....	44
<i>Primary Extended Address</i>	
XRSSI [NONE, –40...–120] .....	44
<i>Extension RSSI Level</i>	
ZONE CLEAR .....	44
<i>Clear Zone Statistics Log</i>	
ZONE DATA .....	44
<i>Read Zone Statistics Log</i>	
<b>7.0 TROUBLESHOOTING.....</b>	<b>45</b>
<hr/>	
7.1 LED Indicators .....	46
7.2 Alarm Codes .....	46
Checking for Alarms—STAT command.....	46
Major Alarms versus Minor Alarms .....	46
Alarm Code Definitions.....	47
7.3 Troubleshooting Chart .....	48
7.4 Performing Network-Wide Remote Diagnostics .....	49
7.5 Internal Fuse Replacement .....	50
<b>8.0 RADIO FIRMWARE UPGRADES.....</b>	<b>51</b>
<hr/>	
8.1 Obtaining New Firmware .....	51
Saving a Web-Site Firmware File Onto Your PC.....	51
8.2 Installing Firmware Into Your Radio .....	51
<b>9.0 OPERATING PRINCIPLES AND CONFIGURATION ...</b>	<b>52</b>
<hr/>	
9.1 SAF Operation with Extension Radios .....	52
Simple Extended SAF Network .....	52
Extended SAF Network .....	53
Retransmission and ARQ Operation .....	53
SAF Configuration Example .....	53
9.2 Synchronizing Network Units .....	54
Synchronization Messages .....	55
9.3 Using AT Commands .....	55
9.4 Configuration Parameters for S&F Services .....	57



9.5	Using the Radio's Sleep Mode (Remote Units Only) .....	59
	Sleep Mode Example.....	60
9.6	Low-Power Mode (LPM)—Master Enabled .....	60
	Setup Commands .....	60
	Reading RSSI & Other Parameters w/LPM Enabled .....	61
	Power Consumption by HOPTIME and SAF Settings .....	61
9.7	Low-Power Mode versus Remote's Sleep Mode .....	62
9.8	Mobile Operation Support .....	62
	Introduction .....	62
	Operational Influences—Hoptime & SAF.....	63
9.9	MIRRORED BITS™ Protocol Support .....	63
9.10	Seamless Mode Emulation .....	63
9.11	Full-Duplex Emulation .....	63
9.12	Co-Located and Close-Proximity Masters .....	63
	Master Station Configuration.....	64
	Antenna System for Co-Located Master Stations .....	64
9.13	Security .....	65
10.0	TECHNICAL REFERENCE .....	66
<hr/>		
10.1	Product Specifications—900 MHz .....	66
10.2	Product Specifications—2.4 GHz .....	67
10.3	Diagnostic Interface Connections (RJ-11) .....	69
10.4	Data Interface Connections (DB-9F) .....	69
	Pin Descriptions—RS/EIA-232 Mode .....	70
	Pin Descriptions—RS/EIA-422/485 Mode .....	71
10.5	Board-Only Supplemental Data .....	72
	Product Differences—Board-only vs. Standard .....	72
	Unit Dimensions.....	72
	Mounting Requirements.....	73
10.6	User Configurable I/O Connections .....	73
	Using the I/O Points with InSite™ NMS Software.....	75
	Application Example—Digital I/O at a Remote .....	75
10.7	dBm-Watts-Volts Conversion Chart .....	76

### Copyright Notice

This manual and all software described herein are Copyright 2013 by GE MDS, LLC. All rights reserved, including the right to correct any errors and omissions in this manual.



## Quality Policy Statement

Our employees are committed to understanding and exceeding our customer's needs and expectations.

- We appreciate our customers' patronage. They are our business.
- We promise to serve them and anticipate their needs.
- We are committed to providing solutions that are cost effective, innovative and reliable, with consistently high levels of quality.

We are committed to the continuous improvement of all of our systems and processes, to improve product quality and increase customer satisfaction.

## RF Exposure Notice

**RF EXPOSURE** Professional installation required. The radio equipment described in this guide emits radio frequency energy. Although the power level is low, the concentrated energy from a directional antenna may pose a health hazard. Do not allow people to come closer than 23 cm (9 inches) to the antenna when the transmitter is operating in indoor or outdoor environments in the 900 MHz band or 11.2 cm (4.4 inches) in the 2400 MHz band. More information on RF exposure is available on the Internet at [www.fcc.gov/oet/info/documents/bulletins](http://www.fcc.gov/oet/info/documents/bulletins).



## RF Safety Notice (English and French)

### RF Exposure

Concentrated energy from a directional antenna may pose a health hazard to humans. Do not allow people to come closer to the antenna than the distances listed in the table below when the transmitter is operating. More information on RF exposure can be found online at the following website: [www.fcc.gov/oet/info/documents/bulletins](http://www.fcc.gov/oet/info/documents/bulletins).



### l'exposition aux RF

Concentré d'énergie à partir d'une antenne directionnelle peut poser un risque pour la santé humaine. Ne pas permettre aux gens de se rapprocher de l'antenne que les distances indiquées dans le tableau ci-dessous lorsque l'émetteur est en marche. Plus d'informations sur l'exposition aux RF peut être trouvé en ligne à l'adresse suivante: [www.fcc.gov/oet/info/documents/bulletins](http://www.fcc.gov/oet/info/documents/bulletins).



### Minimum RF Safety Distance

<b>Safety Distance (900 MHz)</b>	23 cm
<b>Safety Distance (2.4 GHz)</b>	11.2 cm

## ISO 9001 Registration

Microwave Data Systems adheres to the internationally-accepted ISO 9001 quality system standard.

## UL/CSA Notice

The MDS TransNET 900 is available for use in Class I, Division 2, Groups A, B, C & D Hazardous Locations. Such locations are defined in Article 500 of the National Fire Protection Association (NFPA) publication *NFPA 70*, otherwise known as the National Electrical Code. (Approval of the MDS TransNET 2400 is pending as of August 2006.)

The transceiver has been recognized for use in these hazardous locations by two independent agencies —Underwriters Laboratories (UL) and the Canadian Standards Association (CSA). The UL certification for the transceiver is as a Recognized Component for use in these hazardous locations, in accordance with UL Standard 1604, UL508. The CSA Certification is in accordance with CSA STD C22.2 No. 213-M1987.

UL/CSA Conditions of Approval: The transceiver is not acceptable as a stand-alone unit for use in the hazardous locations described above. It must either be mounted within another piece of equipment which is certified for hazardous locations, or installed within guidelines, or conditions of approval, as set forth by the approving agencies. These conditions of approval are as follows:

1. The transceiver must be mounted within a separate enclosure which is suitable for the intended application.
2. The coaxial antenna cable, power input cable and interface cables must be routed through conduit in accordance with Division 2 wiring methods as specified in the National Electrical Code, Article 501.4(B).
3. The transceiver must be used within its Recognized “Ratings”.
4. Installation, operation and maintenance of the transceiver should be in accordance with the transceiver's installation manual, and the National Electrical Code.
5. Tampering or replacement with non-factory components may adversely affect the safe use of the transceiver in hazardous locations, and may void the approval.
6. A power connector with screw-type retaining screws as supplied by MDS must be used.

When installed in a Class I, Div. 2, Groups A, B, C or D hazardous location, observe the following: **WARNING —EXPLOSION HAZARD** Do not disconnect equipment unless power has been switched off or the area is known to be non-hazardous.

Refer to Articles 500 through 502 of the National Electrical Code (NFPA 70) for further information on hazardous locations and approved Division 2 wiring methods.

### **FCC Part 15 Approval Notice**

The products described comply with Part 15 of the FCC Rules. Operation is subject to the following two conditions: (1) this device may not cause harmful interference, and (2) this device must accept any interference received, including interference that may cause undesired operation. This device is specifically designed to be used under Section 15.247 of the FCC Rules and Regulations. Any unauthorized modification or changes to this device without the express approval of the manufacturer may void the user's authority to operate this device. Furthermore, this device is intended to be used only when installed in accordance with the instructions outlined in this manual. Failure to comply with these instructions may void the user's authority to operate this device.

### **Industry Canada Notice**

This Class A digital apparatus complies with Canadian ICES-003.

Cet appareil numérique de la classe A est conforme à la norme NMB-003 du Canada.

### **Servicing Precautions**

When servicing energized equipment, be sure to wear appropriate Personal Protective Equipment (PPE). During internal service, situations could arise where objects accidentally contact or short circuit components and the appropriate PPE would alleviate or decrease the severity of potential injury. When servicing radios, all workplace regulations and other applicable standards for live electrical work should be followed to ensure personal safety. All service must be performed by qualified personnel.

### **Manual Revision and Accuracy**

While every reasonable effort has been made to ensure the accuracy of this manual, product improvements may result in minor differences between the manual and the product shipped to you. If you have additional questions or need an exact specification for a product, please contact our Technical Services team using the information at the back of this guide. In addition, manual updates can often be found online at [www.gemds.com](http://www.gemds.com).

### ESD Notice



To prevent malfunction or damage to this radio, which may be caused by Electrostatic Discharge (ESD), the radio should be properly grounded by connection to a single-point ground that includes the unit's chassis and antenna system. In addition, the installer or operator must observe proper ESD precautions, such as touching a grounded bare metal object to dissipate body charge, prior to connecting or disconnecting cables or performing any other service work.

### Environmental Information



The manufacture of this equipment has required the extraction and use of natural resources. Improper disposal may contaminate the environment and present a health risk due to hazardous substances contained within. To avoid dissemination of these substances into our environment, and to limit the demand on natural resources, we encourage you to use the appropriate recycling systems for disposal. These systems will reuse or recycle most of the materials found in this equipment in a sound way. Please contact your factory representative for more information on the proper disposal of this equipment.

**Battery Disposal**—This product may contain a battery. Batteries must be disposed of properly, and may not be disposed of as unsorted municipal waste in the European Union. See the product documentation for specific battery information. Batteries are marked with a symbol, which may include lettering to indicate cadmium (Cd), lead (Pb), or mercury (Hg). For proper recycling return the battery to your supplier or to a designated collection point.

### Product Test Data Sheets

Test Data Sheets showing the original factory test results for this unit are available upon request from the GE MDS Quality Leader. Contact the factory using the information at the back of this manual. Serial numbers must be provided for each product where a Test Data Sheet is required.



## 1.0 ABOUT THIS MANUAL

This manual presents installation and operating instructions of the MDS TransNET 900™ and MDS TransNET 2400™ transceivers for use by a professional installer. This person is expected to install, operate, and perform basic system maintenance on the described radio. Following installation, we suggest keeping this manual near the equipment for future reference.

**NOTE:** If you have a board-only version of this product, the operating instructions in this manual still apply, but refer also to the supplemental data at the back of this manual (see [Page 72](#)).

## 2.0 PRODUCT DESCRIPTION

The transceiver, shown in [Figure 1](#), is a spread spectrum radio designed for license-free operation. These units employ Digital Signal Processing (DSP) technology to provide highly-reliable long-distance communications, even in the presence of weak signals or interference.

DSP technology also makes it possible to obtain information about radio operation and troubleshoot problems, without going to the Remote radio site. Using appropriate software at the Master station, diagnostic data can be obtained on any DSP radio in the system, even while payload data is being transmitted. (See “[Performing Network-Wide Remote Diagnostics](#)” on [Page 49](#).)

The transceiver is housed in a compact and rugged die-cast enclosure that need only be protected from direct exposure to the weather. It contains a single printed circuit board with all necessary components for radio operation. No jumper settings or manual adjustments are required to configure the radio for operation.



**Figure 1.**  
MDS TransNET  
Series Transceiver

### 2.1 Transceiver Features

Listed below are several key features of the transceiver. These are designed to ease the installation and configuration of the radio, while retaining the ability to make changes in the future.

- 902–928 MHz operation using the TransNET 900



- 2400–2482 MHz ISM band operation with the TransNET 2400
- User-selectable option to skip sub-bands with constant interference
- 65,000 available network addresses
- Network-wide configuration from the Master station eliminates most trips to Remote sites
- Data transparency ensures compatibility with virtually all asynchronous SCADA system RTUs
- Peak-hold RSSI averaged over eight hop cycles
- Operation at up to 115,200 bps continuous data flow
- Store-and-Forward repeater operation
- Data latency typically less than 10 ms
- Same hardware for Master or Remote configuration
- Supports RS/EIA-232 and RS/EIA-485 user interface
- Low current consumption; typically less than 3 mA in “sleep” mode

**NOTE:** Some radio features may not be available on all models, or limited by the options purchased, or the applicable regulatory constraints for the region in which the radio will operate.

## 2.2 Model Number Codes

The radio model number is printed on the label on the end of the radio’s enclosure. It provides key information about how the radio was configured when it was shipped from the factory. This number is subject to many variations depending on what options are installed and where (country) the product is used. Contact the factory if you have questions on the meaning of the code.

## 2.3 Spread Spectrum Radios— How Are They Different?

The main difference between a traditional (licensed) radio and the MDS TransNET transceiver is that this unit “hops” from channel to channel many times per second using a specific hop pattern applied to all radios in the network. A distinct hopping pattern is provided for each of the 65,000 available network addresses, thereby minimizing the chance of interference with other spread spectrum systems. In the USA, and some other countries, no license is required to install and operate this type of radio system, provided that RF power and antenna gain restrictions are observed.

## 2.4 Typical Applications

### Multiple Address Systems (MAS)

This is the most common application of the transceiver. It consists of a central control station (Master) and two or more associated Remote units, as shown in [Figure 2](#). An MAS network provides communications between a central

host computer and remote terminal units (RTUs) or other data collection devices. The operation of the radio system is transparent to the computer equipment. When used in this application, the transceiver provides an excellent alternative to traditional (licensed) MAS radio systems.

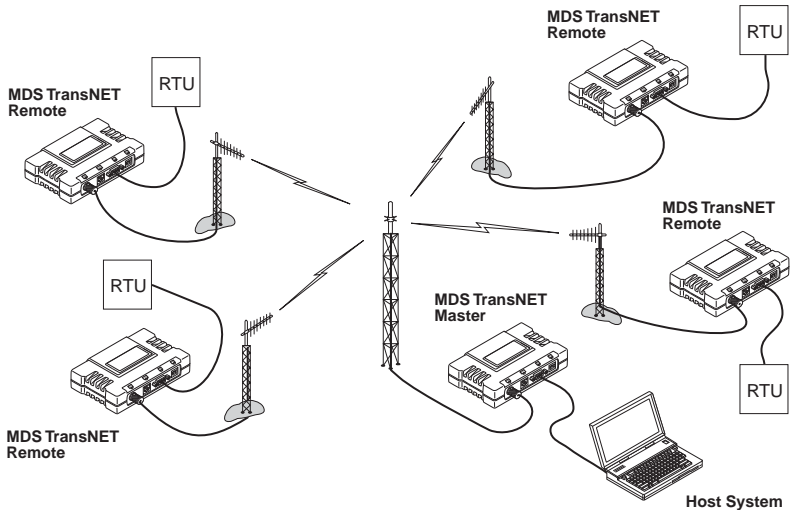

**Figure 2. Typical MAS Network**

### Point-to-Point System

A point-to-point configuration ([Figure 3](#)) is a simple arrangement consisting of just two radios—a Master and a Remote. This provides a half-duplex communications link for the transfer of data between two locations.

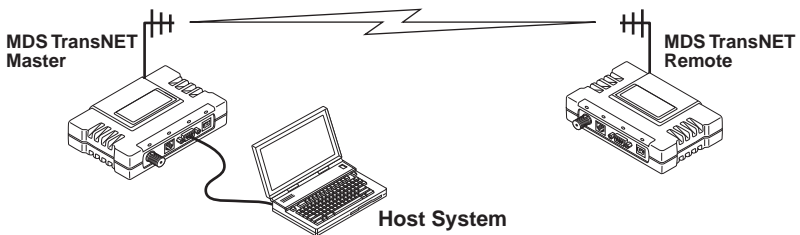

**Figure 3. Typical Point-to-Point Link**

### Adding a Tail-End Link to an Existing Network

A tail-end link can be used to extend the range of a traditional (licensed) MAS system. This might be required if an outlying site is blocked from the MAS Master station by a natural or man-made obstruction. In this arrangement, a

TransNET radio links the outlying Remote site into the rest of a licensed MAS system by sending data from that site to an associated TransNET installed at one of the licensed Remote sites (see [Figure 4](#)).

As the data from the outlying site is received at the licensed Remote site, it is transferred to the licensed radio (via a local cable connection) and is then transmitted to the MAS Master station in the usual manner. Additional details for tail-end links are given in [Section 4.3 \(Page 18\)](#).

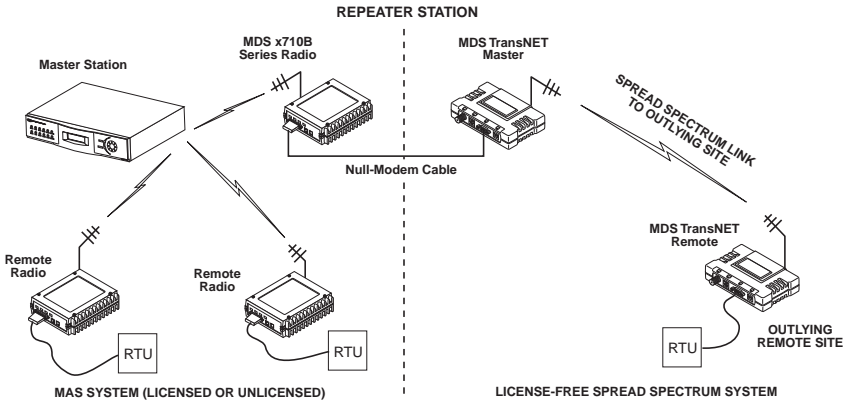

**Figure 4. Typical Tail-End Link Arrangement**

### Extending a TransNET Network with a Repeater

Similar to a Tail-End Link, Store-and-Forward (SAF) offers a way to physically extend the network range, but in a simple and economical manner. SAF works by dividing a network into a vertical hierarchy of two or more sub-networks. Extension radios (designated as **MODE X**) serve as single-radio repeaters that link adjacent sub-networks, and move data from one sub-network to the next one.

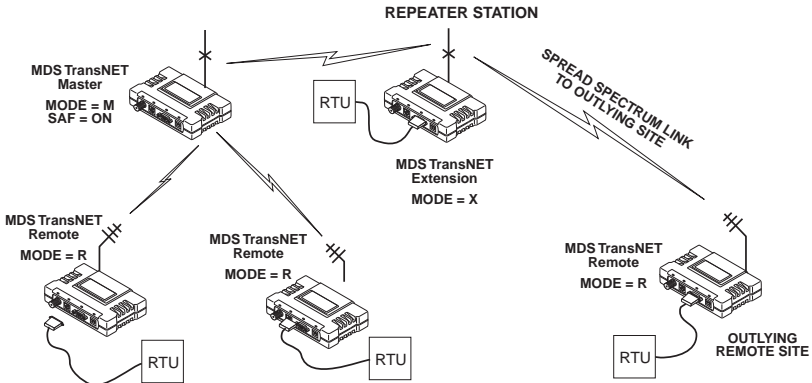

**Figure 5. TransNET Repeater Network**



## 2.5 Accessories

The transceiver can be used with one or more of the accessories listed in [Table 1](#). Contact the factory for ordering details.

**Table 1. Accessories**

Accessory	Description	Part No.
AC Power Adapter	Small power supply module designed for continuous service. UL approved. Input: 120/220 Vac Output: 12 Vdc @ 500 mA (20 Watts)	01-3682A02
2-Pin DC Power Plug	Mates with power connector on the transceiver. Screw terminals are provided for wires.	73-1194A39
Fuse (Internal)	Fuse, 2A SMF Slo-Blo	29-1784A03
Omnidirectional Antennas	Rugged antennas suited for use at Master stations. Consult the factory for details.	Various; Consult factory
900 MHz Yagi Antennas	Rugged directional antennas suited for use at Remote stations. Consult the factory for details.	Various; Consult factory
2400 MHz Antennas	Rugged directional antennas suited for use at Remote stations.	Various; Consult factory
900 MHz Bandpass Filter	Antenna system filter to aid in eliminating interference from paging system transmissions.	20-2822A02
TNC-to-N Adapter Cable (3 ft./1 meter)	Coaxial cable used to connect the radio's TNC antenna connector to a Type-N style commonly used on large-diameter coaxial cables.	97-1677A159
TNC-to-N Adapter Cable (6 ft./1.8 meter)	Coaxial cable used to connect the radio's TNC antenna connector to a Type-N style commonly used on large-diameter coaxial cables.	97-1677A160
TNC-to-N RF Adaptor Plug	Adapts radio's antenna connector to Type-N style commonly used on large-diameter coaxial cables.	97-1677A161
RS/EIA-232 Cable	Shielded data cable fitted with DB-9 male and DB-9 female, 6 ft./1.8 meter.	97-1971A03
RJ-11 to DB-9 Adapter Cable	For connecting a PC terminal to the transceiver via the radio's DIAG(nostics) connector. Used for programming and diagnostics.	03-3246A01
Flat-Surface Mounting Brackets	Brackets: 2" x 3" plates designed to be screwed onto the bottom of the transceiver for surface-mounting the radio.	82-1753-A01
Mounting Bracket Screws	Screws: 6-32/1/4" with locking adhesive. (Industry Standard MS 51957-26)	70-2620-A01
19-Inch Rail Mounting Brackets	Adaptor for mounting the radio in a standard 19-inch equipment rack.	Consult Factory
DIN Rail Mtg. Brackets	Adaptor for mounting the radio in a standard 19-inch equipment rack.	03-4022A01

## 3.0 INSTALLATION PLANNING

The installation of the radio is not difficult, but it does require some planning to ensure station reliability and efficiency. This section provides tips for selecting an appropriate site, choosing an antenna system, and reducing the chance of harmful interference.

### 3.1 General Requirements

There are three main requirements for installing the radio—adequate and stable primary power, a good antenna system, and the compatible interface between the transceiver and the data device.

Figure 6 shows a typical Remote station arrangement. Master stations are similar, but an omni-directional antenna is normally used instead of a directional type, and a host computer replaces the data terminal equipment.

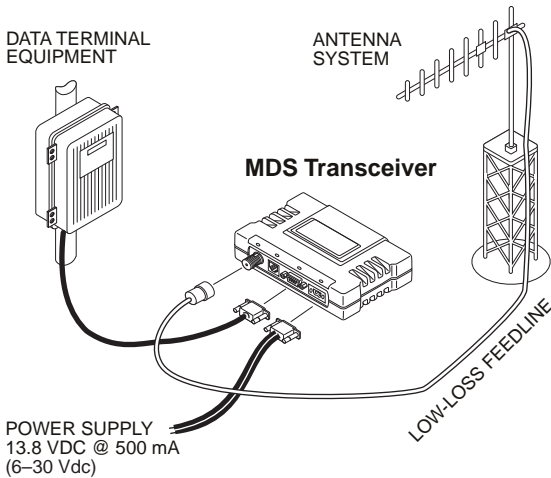

**Figure 6. Typical Remote Station Arrangement**

### 3.2 Site Selection

For a successful installation, careful thought must be given to selecting proper sites for the Master and Remote stations. Suitable sites should provide the following:

- Protection from direct weather exposure
- A source of adequate and stable primary power
- Suitable entrances for antenna, interface or other required cabling
- Antenna location that provides an unobstructed transmission path in the direction of the associated station(s)

These requirements can be quickly determined in most cases. A possible exception is the last item—verifying that an unobstructed transmission path exists. Radio signals travel primarily by line-of-sight, and obstructions between the sending and receiving stations will affect system performance. If you are not familiar with the effects of terrain and other obstructions on radio transmission, the discussion below will provide helpful background.

## **Terrain and Signal Strength**

While the 900 and 2400 MHz bands offer many advantages over VHF and lower UHF frequencies for data transmission, they are more prone to signal attenuation from obstructions such as terrain, foliage or buildings in the transmission path.

A line-of-sight transmission path between the Master station and its associated Remote site(s) is highly desirable and provides the most reliable communications link. A line-of-sight path can often be achieved by mounting the station antenna on a tower or other elevated structure that raises it to a level sufficient to clear surrounding terrain and other obstructions.

The importance of a clear transmission path relates closely to the distance to be covered by the system. If the system is to cover only a limited geographic area, say up to 3 miles (4.8 km), then some obstructions in the communications path can usually be tolerated with minimal impact. For longer range systems, any substantial obstruction in the communications path could compromise the performance of the system, or block communications entirely.

Much depends on the minimum signal strength that can be tolerated in a given system. Fade margin for a TransNET system does not usually have to be as conservative as a licensed system. The nature of TransNET's frequency-hopping algorithm reduces the impact of frequency-selective fading.

Although the exact figure will differ from one system to another, a Received Signal Strength Indication (RSSI) of  $-100$  dBm will often provide acceptable performance. A higher signal strength is generally desirable and may be needed in special cases—for example, urban deployment.

## **Conducting a Site Survey**

If you are in doubt about the suitability of the radio sites in your system, it is best to evaluate them before a permanent installation is begun. This can be done with an on-the-air test (preferred method), or indirectly, using path-study software.

An on-the-air test is preferred because it allows you to see firsthand the factors involved at an installation site and to directly observe the quality of system operation. Even if a computer path study was conducted earlier, this test should be done to verify the predicted results.

The test can be performed by first installing a radio and antenna at the proposed Master station site and then visiting each Remote site with a transceiver and a hand-held antenna.



With the hand-held antenna positioned near the proposed mounting spot, a technician can check for synchronization with the Master station (shown by a lit SYNC lamp on the front panel) and measure the reported RSSI value. If adequate signal strength cannot be obtained, it may be necessary to mount the station antennas higher, use higher gain antennas, or select a different site. To prepare the equipment for an on-the-air test, follow the general installation procedures given in this guide and become familiar with the operating instructions given in Section 5.0, beginning on Page 19.

If time is short, and a site survey is impractical, a computer path study is a good alternative. Factors such as terrain, distance, transmitter power, receiver sensitivity, and other conditions are taken into account to predict the performance of a proposed system. Contact the GE MDS Technical Services Group for more information on path study services.

### 3.3 A Word About Radio Interference

The radio shares the frequency spectrum with other services and other Part 15 (unlicensed) devices in the USA. As such, near 100% error free communications may not be achieved in a given location, and some level of interference should be expected. However, the radio's flexible design and hopping techniques should allow adequate performance as long as care is taken in choosing station location, configuration of radio parameters and software/protocol techniques.

In general, keep the following points in mind when setting up your communications network:

1. Systems installed in rural areas are least likely to encounter interference; those in suburban and urban environments are more likely to be affected by other devices operating in the license-free frequency band and by adjacent licensed services.
2. If possible, use a directional antenna at Remote sites. Although these antennas may be more costly than omnidirectional types, they confine the transmission and reception pattern to a comparatively narrow lobe, which minimizes interference to (and from) stations located outside the pattern.
3. If interference is suspected from a nearby licensed system (such as a paging transmitter), it may be helpful to use horizontal polarization of all antennas in the network. Because most other services use vertical polarization in these bands, an additional 20 dB of attenuation to interference can be achieved by using horizontal polarization.
4. Multiple transceiver systems can co-exist in proximity to each other with only very minor interference as long as they are each assigned a unique network address. Each network address has a different hop pattern.

Additional RF isolation can be achieved by using separate directional antennas with as much vertical or horizontal separation as is practical. Vertical separation of antennas is more effective per foot/meter than horizontal.

5. If constant interference is present in a particular frequency zone, it may be necessary to “lock out” that zone from the radio’s hopping pattern. The radio includes built-in tools to help users remove blocked frequency zones. Refer to the discussion of the **SKIP** command (Page 41) for more information. In the USA, a maximum of four zones may be skipped, per FCC rules. Check the regulatory requirements for your region.
6. Interference can also come from out-of-band RF sources such as paging systems. Installation of a bandpass filter in the antenna system may bring relief. (Contact the Customer Service Department for recommendations and sources of suitable filters.)
7. Proper use of the **RETRY** and **REPEAT** commands may be helpful in areas with heavy interference.

The **RETRY** command sets the maximum number of times (0 to 10) that a radio will re-transmit upstream data over the air. Values greater than 0 successively improve the chances of a message getting through when interference is a problem.

The **REPEAT** command sets a fixed number of unconditional retransmissions for downstream data.
8. The RF power output of all radios in a system should be set for the lowest level necessary for reliable communications. This lessens the chance of causing unnecessary interference to nearby systems.

## 3.4 Antenna & Feedline Selection

### Antennas

The equipment can be used with a number of antennas. The exact style used depends on the physical size and layout of a system. Contact your factory representative for specific recommendations on antenna types and hardware sources.

In general, an omnidirectional antenna (Figure 7 and Figure 8) is used at the Master station site in an MAS system. This provides equal coverage to all of the Remote sites.

**NOTE:** Antenna polarization is important. If the wrong polarization is used, a signal reduction of 20 dB or more will result. Most systems using a gain-type omnidirectional antenna at the Master station employ vertical polarization of the signal; therefore, the Remote antenna(s) must also be vertically polarized (elements oriented perpendicular to the horizon).

When required, horizontally polarized omnidirectional antennas are also available. Contact your factory representative for details.

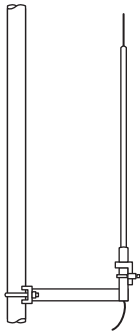

**Figure 7.**  
**Omnidirectional Antenna**  
*(mounted to mast)*

At Remote sites and point-to-point systems, a directional Yagi antenna (Figure 8), is generally recommended to minimize interference to and from other users. Antennas are available from a sources including GE MDS.

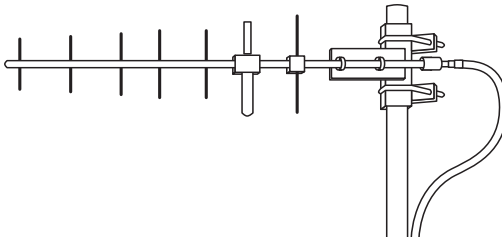

**Figure 8. Typical Yagi Antenna**  
*mounted to a mast*

## Feedlines

The choice of feedline used with the antenna should be carefully considered. Poor-quality coaxial cables should be avoided, as they will degrade system performance for both transmission and reception. The cable should be kept as short as possible to minimize signal loss.

For cable runs of less than 20 feet (6 meters), or for short range transmission, an inexpensive type such as Type RG-8A/U may be acceptable. Otherwise, we recommend using a low-loss cable type suited for 900 MHz, such as Times Microwave LMR 400<sup>®</sup> or Andrew Heliax<sup>®</sup>.

**Table 2** lists several types of feedlines and indicates the signal losses (in dB) that result when using various lengths of each cable at 900 MHz and **Table 3** for 2.4 GHz. The choice of cable will depend on the required length, cost considerations, and the amount of signal loss that can be tolerated.

**Table 2. Length vs. loss in coaxial cables at 900 MHz**

<b>Cable Type</b>	<b>10 Feet (3.05 Meters)</b>	<b>50 Feet (15.24 Meters)</b>	<b>100 Feet (30.48 Meters)</b>	<b>300 Feet (91.44 Meters)</b>
LMR 400	0.39 dB	1.95 dB	3.9 dB	Unacceptable Loss
1/2 inch HELIAX	0.23 dB	1.15 dB	2.29 dB	6.87 dB
7/8 inch HELIAX	0.13 dB	0.64 dB	1.28 dB	3.84 dB
1-1/4 inch HELIAX	0.10 dB	0.48 dB	0.95 dB	2.85 dB
1-5/8 inch HELIAX	0.08 dB	0.40 dB	0.80 dB	2.4 dB

**Table 3. Length vs. loss in coaxial cables at 2400 MHz**

<b>Cable Type</b>	<b>10 Feet (3.05 Meters)</b>	<b>50 Feet (15.24 Meters)</b>	<b>100 Feet (30.48 Meters)</b>	<b>300 Feet (91.44 Meters)</b>
LMR-400	0.70 dB	3.50 dB	6.61 dB	Unacceptable Loss
1/2 inch HELIAX	0.35 dB	1.73 dB	3.46 dB	17.3 dB
7/8 inch HELIAX	0.20 dB	0.99 dB	1.97 dB	9.85 dB
1-1/4 inch HELIAX	0.15 dB	0.73 dB	1.45 dB	7.50 dB

## Antenna System Ground

Precautions should be taken to assure the antenna and its support structure are bonded to a good earth ground system to minimize the impact of voltages created by lightning and atmospheric charges.

**CAUTION:** Safety grounding systems are beyond the scope of this manual. Below you will find some elementary advice. These are generalities; every location and installation is unique and requires a unique safety grounding system design. Please consider consulting a radio system engineer or other professional for advice or ground system design. A well-designed ground system will minimize risk of electrical shock to personnel and the chances of equipment damage.



**Antenna Selection**—Choose an antenna that offers a “DC ground” or direct low-impedance ground connection for all metallic components. This will allow static charges on the antenna system to be safely dissipated to ground. It will also provide a low-impedance discharge path to an earth/safety ground in the event of a direct lightning strike.

**Support Earth/Safety Ground**—The structure that supports your antenna system should have a large-gauge ground wire that goes as directly as possible to an safety/earth ground system. If a tower is used, it should have its own ground system. Support structure grounds can be bonded to the electrical system ground for increased protection. Do not use the building’s AC-power supply ground as a safety ground for lightning protection.

**Chassis Ground**—Connect a safety/earth ground to the ground post provided on the electronic/electrical equipment. If a ground terminal is present, bond the chassis to the safety ground at a point that is as close as possible to the antenna system and primary power entry points on the chassis.

### 3.5 How Much Output Power Can be Used?

The transceiver is normally supplied from the factory set for an RF power of +30 dBm (1 Watt) for 900 MHz and +27 dBm (0.5 Watt) for 2400 MHz; this is the maximum transmitter output power allowed under FCC rules. The power must be decreased from this level if the antenna system gain exceeds 6 dBi. The allowable level is dependent on the antenna gain, feedline loss, and the transmitter output power setting. Power considerations for the transceiver are discussed below.

**NOTE:** In some countries, the maximum allowable RF output may be limited to less than your model’s peak output. Be sure to check for and comply with the requirements for your region.

To determine the maximum allowable power setting of the radio, perform the following steps:

1. Determine the antenna system gain by subtracting the feedline loss (in dB) from the antenna gain (in dBi). For example, if the antenna gain is 9.5 dBi, and the feedline loss is 1.5 dB, the antenna system gain would be 8 dB. (If the antenna system gain is 6 dB or less, no power adjustment is required.)
2. Subtract the antenna system gain from 36 dBm (the maximum allowable EIRP). The result indicates the maximum transmitter power (in dBm) allowed under the rules. In the example above, this is 28 dBm.
3. If the maximum transmitter power allowed in your region is less than 30 dBm, use the **PWR** command (described on [Page 38](#)) to set the power accordingly.



For convenience, [Table 4](#) lists several antenna system gains and shows the maximum allowable power setting of the radio. Note that a gain of 6 dB or less entitles you to operate the radio at full power output—30 dBm (1 watt).

**Table 4. Antenna system gain vs. power output setting (USA)**  
*for 900 MHz models to achieve +36 dBm EIRP*

Antenna System Gain (Antenna Gain in dBi <sup>a</sup> minus Feedline Loss in dB <sup>b</sup> )	Maximum Power Setting (in dBm)	EIRP (in dBm)
6 (or less)	30	36
8	28	36
10	26	36
12	24	36
14	22	36
16	20	36

- a. Most antenna manufacturers rate antenna gain in dBd in their literature. To convert to dBi, add 2.15 dB.
- b. Feedline loss varies by cable type and length. To determine the loss for common lengths of feedline, see [Table 2 on Page 11](#).

**Table 5. Antenna system gain vs. power output setting (USA)**  
*for 2400 MHz models to achieve +36 dBm EIRP*

Antenna System Gain (Antenna Gain in dBi <sup>a</sup> minus Feedline Loss in dB <sup>b</sup> )	Maximum Power Setting (in dBm)	EIRP (in dBm)
2 dB	27	29
10 dB	26	36

- a. Most antenna manufacturers rate antenna gain in dBd in their literature. To convert to dBi, add 2.15 dB.
- b. Feedline loss varies by cable type and length. To determine the loss for common lengths of feedline, see [Table 2 on Page 11](#).

## 4.0 INSTALLATION

Figure 9 shows the contents of a typical transceiver shipment. Check the contents against the packing list secured to the outside of the shipping box. Accessories and spare parts kits, if any, are wrapped separately. Inspect all items for signs of damage and save all packing materials for possible re-shipment.

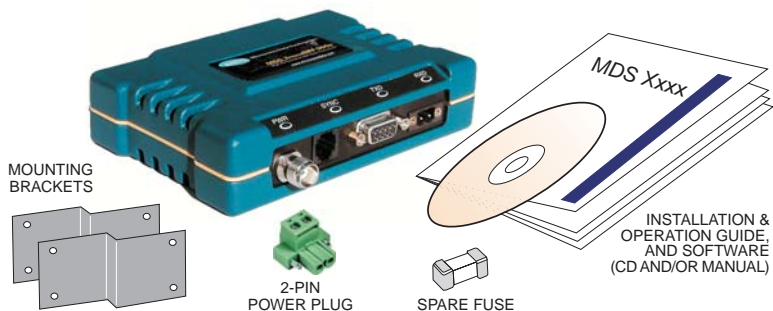

**Figure 9. Typical Transceiver Shipment**

User documentation will be provided as a paper manual and/or as a PDF on the “MDS TransNET Support Package CD” (P/N 03-2708A01). The CD includes:

- Installation & Operation Guide in PDF (Also known as Adobe Acrobat™)
- TransNET Configuration Software

If a paper copy is required but not provided with your shipment, please contact the factory Customer Support Team.

### 4.1 Transceiver Installation

The following is an overview of a typical procedure for installing the transceiver. In most cases, these steps alone will be sufficient to complete the installation. Should further information be required, contact the factory using the information given on the inside back cover of this manual.

If you are installing a tail-end link system, you should also review Section 4.3 (Page 18) for important details on configuration.

**NOTE:** It is recommended that the Master station be installed first. In this way, it will be possible to quickly check the operation of each associated Remote station as it is placed on the air.

1. Mount the transceiver to a stable surface using the brackets supplied with the radio. (Fasteners/anchors are not supplied.) Figure 10 shows the dimensions of the transceiver case and its mounting brackets. If possible,

choose a mounting location that provides easy access to the connectors on the end of the radio and an unobstructed view of the LED status indicators.

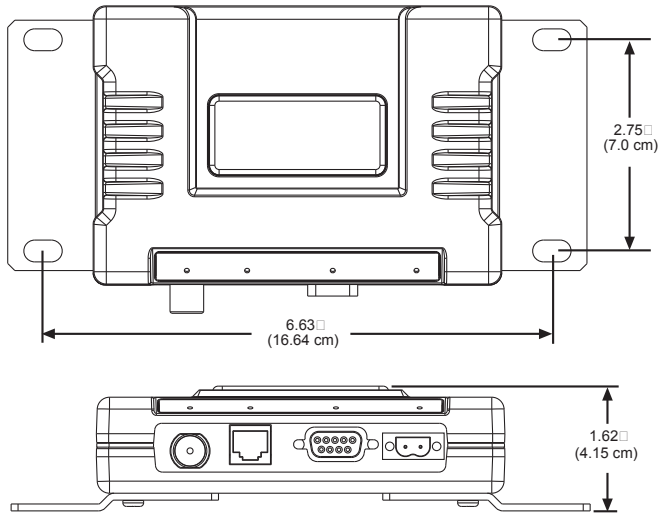

**Figure 10. Transceiver Mounting Dimensions**

Figure 11 shows the four connectors on the transceiver and their functions.

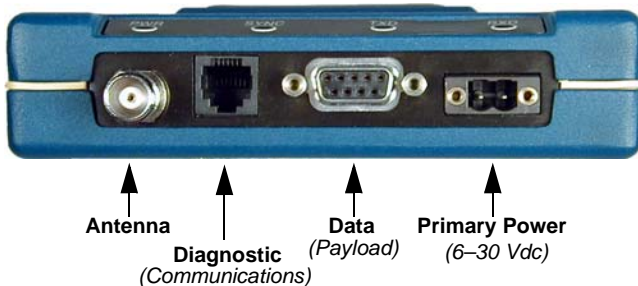

**Figure 11. Interface Connector Functions**

2. Install the antenna and antenna feedline for the station. Antennas should be mounted in the clear and in accordance with the manufacturer's instructions. Additional information on antennas and feedlines is contained in Section 3.4 on Page 9.

**NOTE:** It is recommended to mount the antenna be at least 10 feet (>3 meters) from the radio, RTU, sensors and other components of the system to prevent RFI.

3. Connect the data equipment to the transceiver's DATA connector. Use only the required pins for the application.

Typical RS/EIA-232 applications require the use of Pin 2 (receive data—RXD) and Pin 3 (transmit data—TXD). Some systems may require the use of Pin 7 (Request-to-send—RTS). [Figure 13](#) shows connection details for the DATA connector for EIA/RS-232 and EIA/RS-485, respectively.

If hardware flow control is desired, Pin 7 (RTS) and Pin 8 (CTS) may also be connected. For a more detailed discussion of pin functions, see “[Data Interface Connections \(DB-9F\)](#)” on page 69.

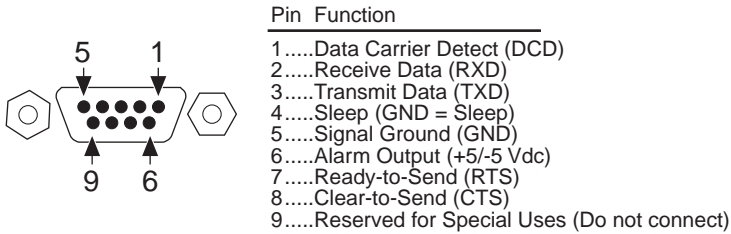

**Figure 12. DATA Connector Pin Functions, EIA/RS-232 Mode**  
*As viewed from outside the radio*

**NOTE:** The data cabling between the transceiver and the connected device should be kept as short as possible. For EIA/RS-232 operation, the maximum recommended cable length is 50 feet/15 meters.

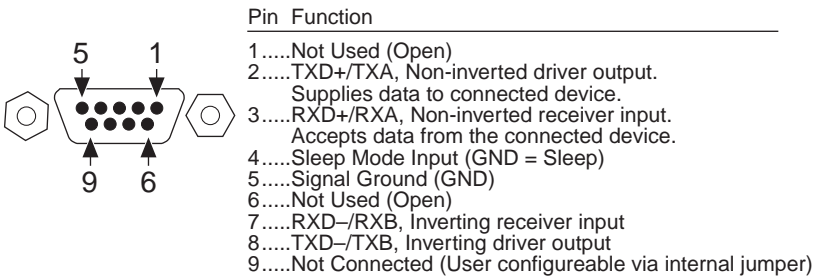
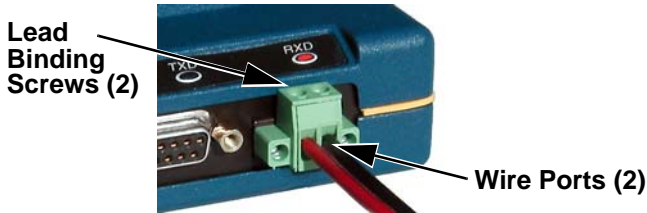

**Figure 13. DATA Connector Pin Functions, EIA/RS-485 Mode**  
*As viewed from outside the radio*

- Measure and install the primary power for the transceiver. It must be within 6–30 Vdc (including transients) and be capable of providing 7.5 watts over this voltage range. (Typical current draw is 400 mA @ 13.8 Vdc; 0.9 A @ 6 Vdc.) A power connector with screw-terminals is provided with each unit. Strip the wire leads to 0.25"/6 mm. Be sure to observe proper polarity. The left pin is the positive input; the right is negative. (See [Figure 14](#).)

**CAUTION**  
POSSIBLE  
EQUIPMENT  
DAMAGE

The radio must be used only with negative-ground systems. Make sure the polarity of the power source is correct. The unit is protected from reverse polarity by an internal diode and fuse.



**Figure 14. Power Connector**  
(Polarity: Left +, Right –)

**CAUTION**  
POSSIBLE  
EQUIPMENT  
DAMAGE

The power connector used with the MDS TransNET transceiver is similar to that used by other MDS products, such as the MDS 9810 and MDS x710 family. The connectors are *not* equal and the use of the other style connector may provide unreliable connections and a spark may be created.

Only the power connector, shown in [Figure 14](#) with screw terminals and two retainer screws should be used with this unit.

5. Set the radio's basic configuration with a PC terminal connected to the DIAG(nostics) connector via an RJ-11 to DB-9 adapter cable, P/N 03-3246A01. (If necessary, a cable of this type may be constructed using the information shown in [Figure 21 on Page 69](#).) For more information on connecting a PC terminal and preparing it for use, refer to [Section 6.1 on Page 22](#).

The three essential settings for the Transceiver are as follows:

**Mode**—Master, Remote, or Extension

**Network Address**—a unique number from 1 to 65000

**Data Interface Parameters**—bps, data bits, parity, stop bits

- a. Set the Mode using the **MODE M** (Master), **MODE R** (Remote), or **MODE X** (Extension) command. (Note: There can be only *one* Master radio in a system.)

If *any* **MODE X** radios are used in the network, SAF must be turned on at the Master station. The **MODE X** radio must be programmed with an Extended Address (**XADDR**). Units that need to hear the **MODE X** radio must be programmed with an appropriate **XPRI** and/or **XMAP** value. (See "[SAF Operation with Extension Radios](#)" on [Page 52](#) for more information.)



- b. Set a unique Network Address (1–65000) using **ADDR** command. Each radio in the system *must* have the same network address. *Tip: Use the last four digits of the Master’s serial number to help avoid conflicts with other users.*
- c. Set the baud rate/data interface parameters. Default setting is 9600 bps, 8 data bits, no parity, 1 stop bit. If changes are required, use the **BAUD xxxxx abc** command where **xxxxx** equals the data speed (300–115200 bps) and **abc** equals the communication parameters as follows:
  - a** = Data bits (7 or 8)
  - b** = Parity (N for None, O for Odd, E for Even)
  - c** = Stop bits (1 or 2)

**NOTE:** 7N1, 8E2 and 8O2 are invalid interface parameters.

## 4.2 Configuring Multiple Remote Units

In most installations, the Remote radios will be programmed with virtually the same set of parameters. This process can be streamlined by testing key pieces of equipment—such as the Master, any Extensions, and a typical Remote—on a benchtop setup prior to installation. This allows you to test various configurations in a controlled environment. Once the evaluation network is working satisfactorily, you can save the configuration of each unit in a data file on your PC’s hard drive through the use of the *MDS TransNET Configuration Software* (included on the support CD shipped with the radio, part number 03-2708A01). Most often, there are many Remote units that will need configuring. Using the *MDS TransNET Configuration Software*, you can save the sample unit’s configuration, then open the configuration file with the program and install it in the next Remote. The software will prevent you from overwriting unit or mode-unique parameters.

## 4.3 Tail-End Links

A tail-end link is established by connecting an MDS TransNET Series radio “back-to-back” with another identical radio such as a licensed MDS x710B Series transceiver. This can be used to link an outlying Remote site into the rest of an MAS network. (Figure 4 on Page 4 shows a diagram of a typical tail-end link system.) The wiring connections between the two radios in a tail-end link system should be made as shown in Figure 15.

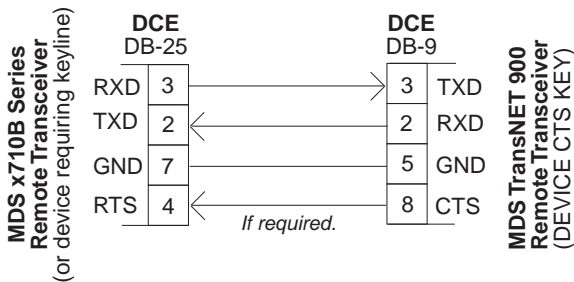

**Figure 15. Data Interface Cable Wiring for Tail-End Links**

Any device on the left that requires a keyline, as in this illustration, will require the bottom line (CTS to RTS) and the TransNET on the right will need **DEVICE** type set to **CTS KEY**. See **DEVICE**, on [Page 32](#) for details.

## 4.4 Configuring a Network for Extensions

The installation and configuration of an Extension transceiver is straightforward with only a few unique parameters that need to be considered and set at each unit.

In every network there can be only one Master station. It will serve as the sole gateway to the outside world. The tables in [“Configuration Parameters for Store-and-Forward Services” on Page 57](#) detail the parameters that need to be set on each type of radio in the network. For a detailed description of this network design, see [“SAF Operation with Extension Radios” on page 52](#).

## 5.0 OPERATION

### 5.1 Initial Start-up

In-service operation of the transceiver is completely automatic. Once the unit has been properly installed and configured, operator actions are limited to observing the LED status indicators for proper operation.

If all parameters are correctly set, start operation of the radio as follows:

1. Apply primary power.
2. Observe the transceiver LED status panel for proper indications. [Table 6](#) provides an explanation of the LED functions.

In a normally operating system, the following indications will be seen within 16 seconds of start-up:

- PWR lamp lit continuously
- SYNC lamp lit continuously

- Remote radio(s) transmitting data (TXD) and receiving data (RXD) with Master station

**Table 6. LED indicator descriptions**



Name	Description
<b>PWR</b>	<ul style="list-style-type: none"> <li>• Continuous—Power is applied to the radio; no problems detected</li> <li>• Flashing (5 times-per-second)—Fault indication See <a href="#">“TROUBLESHOOTING”</a> on Page 45</li> <li>• Off—Radio is unpowered or in Sleep mode See also, <a href="#">“LED [ON, OFF]”</a> on Page 36</li> </ul>
<b>SYNC</b>	Continuous—Radio is receiving/sending synchronization frames On within 10 seconds of power-up under normal conditions
<b>TXD</b>	Transmit data activity on the DB-9 DATA interface connector Payload data to connected device
<b>RXD</b>	Receive data activity on the DB-9 DATA interface connector. Payload data from the connected device

## 5.2 Performance Optimization

After the basic operation of the radio has been checked, you may wish to optimize its performance using some of the suggestions given here. The effectiveness of these techniques will vary with the design of your system and the format of the data being sent.

Complete instructions for using the commands referenced in this manual are provided in [“RADIO PROGRAMMING”](#) on Page 22.

### Antenna Aiming

For optimum performance, directional antennas must be accurately aimed in the direction of desired transmission. The easiest way to do this is to point the antenna in the approximate direction, then use the Remote radio’s **RSSI** command (Received Signal Strength Indicator) to further refine the heading for maximum received signal strength.

In an MAS system, RSSI readings are only meaningful when initiated from a Remote station. This is because the Master station typically receives signals from several Remote sites, and the RSSI would be continually changing as the Master receives from each Remote in turn. Adjust the antenna for the highest (most positive) value to insure the greatest communication reliability.



## Antenna SWR Check

It is necessary to briefly key the transmitter for this check by placing the radio in the **SETUP** mode ([Page 40](#)) and using the **KEY** command. (To unkey the radio, enter **DKEY**; to disable the **SETUP** mode and return the radio to normal operation, enter **Q** or **QUIT**.)

The SWR of the antenna system should be checked before the radio is put into regular service. For accurate readings, a wattmeter suited for 1000 MHz is required. One unit meeting this criteria is the Bird Model 43 directional wattmeter with a 5J element installed.

The reflected power should be less than 10% of the forward power ( $\approx 2:1$  SWR). Higher readings usually indicate problems with the antenna, feedline or coaxial connectors.

## Data Buffer Setting—Modbus Protocol

The default setting for the data buffer is **OFF**. This allows the radio to operate with the lowest possible latency and improves channel efficiency. MODBUS and its derivatives are the only protocols that should require the buffer to be turned on. See “[BAND \[A, B, C\]](#)” on [Page 30](#) for details.

## Hoptime Setting

The default hop-time setting is **7** (7 ms). Alternate settings of **14** and **28** milliseconds can be used to increase throughput, but at the cost of increased latency. A detailed explanation of the **HOPTIME** command can be found on [Page 34](#).

## TotalFlow™ Protocol at 9600 with Sleep Mode

For reliable operation with TotalFlow meters, use the default settings for 9600 with the following alterations:

**HOPTIME 28**—Allows large data packets

**FEC OFF**—Improves store-and-forward performance for a large continuous data stream

**BUFF ON**—Ensures “ungapped” 4-second polls if unit in sleep mode

## Operation at 115200 bps

Burst throughput at 115200 bps is supported at all settings. The radio will always buffer at least 500 characters. Sustained throughput at 115200 bps is only possible when the data path is nearly error-free and the operating settings have been properly selected. For sustained operation at 115200 bps, use the following settings: **SAF OFF**, **FEC OFF**, **REPEAT 0**, **RETRY 0**, **HOPTIME 28**.



## Baud Rate Setting

The default baud rate setting is 19200 bps to accommodate most systems. If your system will use a different data rate, you should change the radio's data interface speed using the **BAUD xxxxx abc** command ([Page 29](#)). It should be set to the highest speed that can be sent by the data equipment in the system. (The transceiver supports 300 to 115200 bps.)

## Radio Interference Checks

The radio operates in eight frequency zones. If interference is found in one or more of these zones, the **SKIP** command ([Page 41](#)) can be used to omit them from the hop pattern. You should also review [Section 3.3, A Word About Radio Interference](#), when dealing with interference problems.

# 6.0 RADIO PROGRAMMING

There are no manual adjustments on the radio. Programming and control is performed through a PC connected to the radio's DIAG connector.

## 6.1 Radio Programming Methods

### Terminal Interface

A PC may be used by operating it in a basic terminal mode (for example, a HyperTerminal session) and entering the radio commands listed in the tables found in ["User Commands" on Page 23](#). The PC must be connected to the radio's DIAG connector using an RJ-11 to DB-9 Adapter Cable (P/N 03-3246A01). If desired, a cable of this type may be constructed using the information shown in [Figure 21 on Page 69](#).

Once connected, communication (baud rate) is established through the command interface. To access the command interface, press the **ESC** key, followed by one or more **ENTER** keystrokes (delivered at about half-second intervals), until the ">" prompt is displayed.

**NOTE:** The DIAG port (RJ-11 connector) uses 8 data bits, 1 stop bit, and no parity. It can automatically configure itself to function at 1200, 2400, 4800, 9600, 19200, 38400, 57600, and 115200 bps. [Default: **BAUD** = 9600]

If the **DLINK** setting is **ON**, the DIAG port will start out in Diagnostic Link mode. This is a special protocol used to support Network-Wide Diagnostics. The process described in the paragraph above causes the radio to exit the diagnostic link mode and enter the command mode. If there is no input in command mode for 5 minutes, the DIAG port will revert back to diagnostic link mode.

### PC-Based Configuration Tool

The MS Windows™-based *MDS TransNET Configuration Software* (P/N 06-4059A01) is designed for use with a PC connected to the radio's DIAG connector through an RJ-11 to DB-9 cable assembly (Part No. 03-3246A01). A cable of this type may be constructed using the information shown in [Figure 21 on Page 69](#).

The *TransNET Configuration Software* provides access to all of the radio's capabilities with the benefit of context-sensitive help. The program is shipped as part of the TransNET support CD included with every order (CD P/N 03-2708A02)

## 6.2 User Commands

A series of tables begin on the next page that provide reference charts of various user commands for the transceiver. See “[Detailed Command Descriptions](#)” on [Page 28](#) for more details.

### Entering Commands

The proper procedure for entering commands is to type the command, followed by an **[ENTER]** keystroke. For programming commands, the command is followed by **[SPACE]**, the appropriate information or values, and then **[ENTER]**.

**Table 7. Network Configuration—Master Station**

COMMAND	DESCRIPTION
<b>AT [ON, OFF]</b> <i>Details Page 29</i>	Enables Master station to emulate a modem and respond to AT commands
<b>BUFF [ON, OFF]</b> <i>Details Page 30</i>	ON = Seamless data OFF = Fast byte throughput.
<b>FEC [ON, OFF]</b> <i>Details Page 33</i>	Sets/disables FEC (Forward Error Correction) setting.
<b>HOPTIME [7, 28]</b> <i>Details Page 34</i>	Displays hop-time or sets it to 7 or 28 ms.
<b>LPM [1, 0]</b> <i>Details Page 36</i>	Used at Master to set all associated stations in an energy-conservation mode. 1 = Low-power mode enabled network-wide 0 = Disable low-power mode (Default)
<b>REPEAT</b> <i>Details Page 38</i>	Sets/displays the fixed downstream re-send count.
<b>RETRY [0–10]</b> <i>Details Page 38</i>	Sets/displays the maximum upstream re-send count for ARQ (Automatic Repeat Request) operation
<b>SAF [ON, OFF]</b> <i>Details, Page 40</i>	Enables/disables the store-and-forward function for the network controlled by this Master unit.
<b>SKIP [NONE, 1...8]</b> <i>Details, Page 41</i>	Skip one or more frequency zones



**Table 8. Network-Wide Diagnostics**

Command	Description
<b>DLINK [xxxxx/ON/OFF]</b> <a href="#">Details</a> , <a href="#">Page 32</a>	Controls operation of diagnostic link function.
<b>DTYPE [NODE/ROOT]</b> <a href="#">Details</a> , <a href="#">Page 33</a>	Set radio's operational characteristics for network-wide diagnostics

**Table 9. Operational Configuration—Set/Program**

Command	Description
<b>ADDR [1–65000]</b> <a href="#">Details</a> , <a href="#">Page 29</a>	Program network address
<b>AMASK [0000 0000–FFFF FFFF]</b> <a href="#">Details</a> , <a href="#">Page 29</a>	Alarm response Default: FFFF FFFF
<b>ASENSE [HI/LO]</b> <a href="#">Details</a> , <a href="#">Page 29</a>	Sense of the alarm output on Pin 6 of the DATA interface connector in the EIA-232 mode. Default: Alarm present = HI
<b>BAND [A, B, C]</b> <a href="#">Details</a> <a href="#">Page 30</a>	Selects one of three operating bands. (2.4 GHz Model Only)
<b>BAUD [xxxxx abc]</b> <a href="#">Details</a> , <a href="#">Page 29</a>	Data communication parameters
<b>CODE [NONE, 1...255]</b> <a href="#">Details</a> , <a href="#">Page 31</a>	Select the security/encryption setting in the radio
<b>CSADDR [1–65000, NONE]</b> <a href="#">Details</a> , <a href="#">Page 31</a>	Used on a single Master/Remote network to support TDD-style simulated full-duplex.
<b>CTS [0–255]</b> <a href="#">Details</a> , <a href="#">Page 31</a>	CTS delay in milliseconds (A value of 0 returns CTS immediately)
<b>CTSHOLD [0–60000]</b> <a href="#">Details</a> , <a href="#">Page 32</a>	“Hold time” that CTS is present following last character from DATA port.
<b>DEVICE [DCE, CTS KEY]</b> <a href="#">Details</a> , <a href="#">Page 32</a>	Device behavior: DCE (normal) or CTS Key
<b>MODE [M, R, X]</b> <a href="#">Details</a> , <a href="#">Page 36</a>	Operating mode: M = Master, R = Remote, X = Extension
<b>MRSSI [NONE, –40...–90]</b> <a href="#">Details</a> , <a href="#">Page 37</a>	Minimum RSSI level required to preserve synchronization with a Master radio for Remotes in mobile service.
<b>OT [ON, OFF]</b> <a href="#">Details</a> , <a href="#">Page 37</a>	Enables a 1-second delay on delivery of RXD serial data.

**Table 9. Operational Configuration—Set/Program (Continued)**

Command	Description
<b>OWN [xxxxx]</b> <a href="#">Details, Page 37</a>	Owner's name, or alternate message (30 characters maximum)
<b>PORT [RS232, RS485]</b> <a href="#">Details, Page 37</a>	Data port (DATA connector) interface signaling mode: RS232 or RS485
<b>PWR [20–30]</b> <a href="#">Details, Page 38</a>	Power output in dBm (Figure 30 on Page 76)
<b>RXD [0–255]</b> <a href="#">Details, Page 39</a>	Set RXD delay time for virtual seamless mode with low latency
<b>RXTOT [NONE, 0–1440]</b> <a href="#">Details, Page 40</a>	Maximum duration (in minutes) before time-out alarm. Default is OFF.
<b>RTU [ON, OFF, 0-80]</b> <a href="#">Details, Page 39</a>	Enable or Disable unit's built-in RTU simulator. Default is OFF. Set RTU address between zero and 80.
<b>SLEEP [ON, OFF]</b> <a href="#">Details, Page 42</a>	Enable or Disable the radio's energy-conservation Sleep mode function.
<b>UNIT [10000–65000]</b> <a href="#">Details, Page 43</a>	Unit address used for network-wide diagnostics. (Unique within associated network.)
<b>XADDR [0–31]</b> <a href="#">Details, Page 44</a>	This unit's Extended address Typically, the Master is set to zero (0).
<b>XMAP [00000000-FFFFFFFF]</b> <a href="#">Details, Page 44</a>	Included Extended units in MODE X. (Extensions and Remotes only)
<b>XPRI [0–31]</b> <a href="#">Details, Page 44</a>	Address of the primary Extended radio unit (Extension).
<b>XRSSI [NONE, –40...–120]</b> <a href="#">Details, Page 44</a>	Minimum RSSI level required to preserve synchronization with a non-primary radio. (Only meaningful when XPRI is not NONE)
<b>ZONE CLEAR</b> <a href="#">Details, Page 44</a>	Reset zone data statistics

**Table 10. Operating Status—Display Only**

Command	Description
<b>ADDR</b> <a href="#">Details Page 29</a>	Network address
<b>AMASK</b> <a href="#">Details Page 29</a>	Alarm mask (response)

**Table 10. Operating Status—Display Only** *(Continued)*

<b>Command</b>	<b>Description</b>
<b>ASENSE</b> <i>Details Page 29</i>	Current sense of the alarm output.
<b>BAUD</b> <i>Details Page 29</i>	Data communication parameters. Example: BAUD 9600 8N1
<b>BUFF</b> <i>Details Page 30</i>	Data buffering mode: ON = seamless data, OFF = fast byte throughput
<b>CODE</b> <i>Details Page 30</i>	Security/encryption operational status. “NONE” (Inactive), or “ACTIVE”
<b>CTS</b> <i>Details Page 31</i>	CTS delay in milliseconds (0–255 ms)
<b>CTSHOLD</b> <i>Details Page 32</i>	“Hold time” that CTS is present following last character from DATA port.
<b>DEVICE</b> <i>Details Page 32</i>	Device behavior Alternatives: DCE and CTS KEY
<b>HOPTIME</b> <i>Details Page 34</i>	Hop-time value in milliseconds (ms).
<b>LPMHOLD</b> <i>Details Page 36</i>	Time (0-1000 ms) provided to give an RTU time to respond before the radio goes to sleep.
<b>MODE</b> <i>Details Page 36</i>	Current operating mode: M = Master R = Remote X = Extension (Repeater)
<b>MRSSI</b> <i>Details Page 37</i>	Minimum RSSI level required to preserve syn- chronization with a Master radio for Remotes in mobile service.
<b>OWM</b> <i>Details Page 37</i>	Owner’s message or site name
<b>OT</b> <i>Details Page 37</i>	Status (ON/OFF) of the 1-second delay on delivery of RXD serial data.
<b>OWN</b> <i>Details Page 37</i>	Owner’s name or system name
<b>PORT</b> <i>Details Page 37</i>	Current data port (DATA connector) interface signaling mode: RS232 or RS485
<b>PWR</b> <i>Details Page 38</i>	Forward power-output setting in dBm

**Table 10. Operating Status—Display Only (Continued)**

<b>Command</b>	<b>Description</b>
<b>REPEAT</b> <i>Details Page 38</i>	The fixed downstream re-send count.
<b>RETRY</b> <i>Details Page 38</i>	The maximum upstream re-send count for ARQ (Automatic Repeat Request) operation.
<b>RSSI</b> <i>Details Page 38</i>	Received signal strength indicator (in dBm). Unavailable at Master unless SETUP is enabled.
<b>RTU</b> <i>Details Page 39</i>	RTU simulator's operational status (ON/OFF)
<b>RXTOT</b> <i>Details Page 40</i>	The amount of time (in seconds) to wait before issuing a time-out alarm.
<b>SAF</b> <i>Details Page 40</i>	Store-and-forward mode status in this unit. (ON/OFF)
<b>SER</b> <i>Details Page 40</i>	Serial number of radio
<b>SHOW CON</b> <i>Details Page 41</i>	Display virtual modem connection status
<b>SHOW PWR</b> <i>Details Page 41</i>	RF output power. Measured RF power in dBm.
<b>SHOW SYNC</b> <i>Details Page 41</i>	Information on synchronization source
<b>SKIP</b> <i>Details Page 41</i>	Frequency zones that are skipped
<b>SLEEP</b> <i>Details Page 42</i>	Radio's Sleep Mode setting. (At Remotes Only)
<b>SREV</b> <i>Details Page 42</i>	Transceiver firmware revision level
<b>STAT</b> <i>Details Page 43</i>	Current alarm status
<b>TEMP</b> <i>Details Page 43</i>	Transceiver's internal temperature (°C)
<b>UNIT</b> <i>Details Page 43</i>	Programmed unit address for network-wide diagnostics
<b>XADDR</b> <i>Details Page 44</i>	This unit's Extended address



**Table 10. Operating Status—Display Only** *(Continued)*

Command	Description
<b>XPRI</b> <i>Details Page 44</i>	Address of the primary Extended radio unit (Extension).
<b>XMAP</b> <i>Details Page 44</i>	Included Extended units in MODE X. (Extensions and Remotes only).
<b>XRSSI</b> <i>Details Page 44</i>	Minimum RSSI level required to preserve synchronization with a non-primary radio. (Only meaningful when XPRI is not NONE)

**Table 11. Diagnostic and Test Functions**

Command	Description
<b>KEY</b> <i>Details Page 35</i>	Enables the transmitter test. (Must be in Setup mode. Details on <a href="#">Page 40.</a> )
<b>DKEY</b> <i>Details Page 33</i>	Turns off the transmitter test. (Must be in Setup mode. Details on <a href="#">Page 40.</a> )
<b>TX [xxxx]</b> <i>Details Page 43</i>	Set/display transmit test frequency. (Must be in Setup mode. Details on <a href="#">Page 40.</a> )
<b>RX [xxxx]</b> <i>Details Page 39</i>	Set/display receive test frequency. (Must be in Setup mode. Details on <a href="#">Page 40.</a> )
<b>SETUP</b> <i>Details Page 40</i>	Enables Setup mode. Times out after 10 minutes. Press “Q” to quit.
<b>ZONE DATA</b> <i>Details Page 44</i>	Zone data statistics
<b>ZONE CLEAR</b> <i>Details Page 44</i>	Clears the Zone Data log

### 6.3 Detailed Command Descriptions

The essential commands for most applications are Network Address (**ADDR**), Mode (**MODE**), and Baud Rate (**BAUD**). However, proper use of the additional commands allows you to tailor the transceiver for a specific use, or to conduct basic diagnostics on the radio. This section gives more detailed information for the commands listed above in Section 6.2.

Most of the commands below can be used in two ways. First, you can type only the command name (for example, **ADDR**) to view the currently programmed data. Second, you can set or change the existing data by typing the command, followed by a space, and then the desired entry (for example, **ADDR 1234**). In the descriptions which follow, allowable programming variables, if any, are shown in brackets [ ] following the command name.



## **ADDR [1–65000]**

### *Network Address*

This command sets or displays the radio's network address. The network address can range from 1 to 65000.

*A network address must be programmed at the time of installation and must be common across each radio in a given network.* Radios are typically shipped with the network address unprogrammed, causing the address to display as **NONE**. If the address is not set (or is set to a wrong value) it leaves the system in an invalid state, preventing operation and generating an alarm.

**NOTE:** It is recommended that the last four digits of the Master radio's serial number be used for the network address. This helps avoid conflicts with other users.

## **AMASK [0000 0000–FFFF FFFF]**

### *Alarm Mask*

This command sets the alarm bits that cause the alarm output signal to be triggered. The PWR LED will still flash for all alarms, but the alarm output signal will only be activated for those alarms that have the corresponding mask bit set. The hex value for the mask aligns directly with the hex value for the **ALARM** command. The default is **FFFF FFFF**. Through proper use of the **AMASK** command, it is possible to tailor the alarm response of the radio. Refer to the *Using the AMASK Command Application Bulletin* (AP\_08004) for more information on configuring the alarm mask.

## **AT [ON, OFF]**

### *Hayes-Compatible AT Command Support*

AT-style modem commands, also known as “Hayes-Compatible Commands”, can be processed through the payload port. By setting **AT ON** at the Master (**MODE M**), individual Remotes can be accessed by using **ATDT** [Unit Address]. In this mode, RTUs designed only for dial-up access can be accessed through the Master station. For more details, see See [“Using AT Commands” on Page 55](#) and [“OT \[ON, OFF\]” on Page 37](#).

## **ASENSE [HI/LO]**

### *Alarm Output Sense*

This command is used to set the sense of the alarm output at Pin 6 of the DATA connector. The default is **HI** which means an alarm is present when an RS-232 high is on Pin 6.

## **BAUD [xxxxx abc]**

### *Data Interface Port Baud Rate*

This command sets or displays the communication attributes for the normal payload communications through the DATA port. The command has no effect on the RJ-11 DIAG(NOSTICS) port.



The first parameter (**xxxxx**) is baud rate. Baud rate is specified in bits-per-second and must be one of the following speeds: 300, 600, 1200, 1800, 2400, 4800, 9600, 19200, 38400, 57600, or 115200. At baud rates of 19200 bps or less, the radio can support unlimited continuous data transmission at any hop rate.

The second parameter of the **BAUD** command (**abc**) is a 3-character block indicating how the data is encoded. The following is a breakdown of each character's meaning:

- a** = Data bits (7 or 8)
- b** = Parity (**N** for None, **O** for Odd, **E** for Even)
- c** = Stop bits (1 or 2)

The factory default setting is 9600 baud, 8 data bits, no parity, 1 stop bit (Example: **9600 8N1**).

**NOTE:** 7N1, 8O2, and 8E2 are invalid communication settings and are not supported by the transceiver.

## **BAND [A, B, C]**

*Select Sub-Band (Normally used for 2.4 GHz units)*

This command sets or displays the receiving and transmit operating band for the radio.

- A** = 2.4016–2.4270 GHz
- B** = 2.4272–2.4526 GHz
- C** = 2.4528–2.478.2 GHz

**NOTE:** The same **BAND** must be programmed at the time of installation and must be common across each radio in a given network.

## **BUFF [ON, OFF]**

*Data Buffer Mode*

This command sets or displays the received data handling mode of the radio. The command parameter is either **ON** or **OFF**. (The default is **OFF**.) The setting of this parameter affects the timing of received data sent out the DATA connector. Data transmitted over the air is unaffected by the **BUFF** setting.

If data buffering is set to **OFF**, the radio will operate with the lowest possible average latency. Data bytes are sent out the DATA port as soon as an incoming RF data frame is processed. Average and typical latency will both be below 10 ms, but idle character gaps may be introduced into the outgoing data flow.

If data buffering is **ON**, the radio will operate in a seamless mode. That is, data bytes will be sent over the air as quickly as possible, but the receiver will buffer the data until the entire packet has been collected. The delay introduced by data buffering is variable and depends on message size and the number of retransmissions required, but the radio will not create any gaps in the output data stream. This mode of operation is required for protocols such as MODBUS™ that do not allow gaps in their data transmission.

Seamless mode (**BUFF ON**) is intended only for applications where the message size is 256 characters or less. Enforcement of this rule is left up to the user. If more than 256 characters are transmitted data delivery will not be seamless and data may be lost.

Changes to the **BUFF** setting may only be made at the Master radio. This is because the Master radio broadcasts the buffer setting for the entire network. At Remote radios, the buffer setting may be read when the radio is in synchronization with the Master, but it cannot be changed.

## **CODE [NONE, 1...255]**

### *Security Code*

The **CODE** command is used to select or display the security/encryption setting in the radio.

The default is **CODE NONE**. Setting **CODE** to a value other than **NONE** provides an extra level of security beyond that provided by the Network Address (**ADDR**). The disadvantage is increased complexity in managing the network.

The **CODE** command takes an argument **1...255**, or **NONE**. Entering **CODE** without an argument will display either **NONE** or **ACTIVE**. **ACTIVE** means that security/encryption has been enabled, but the radio *will not* display the security argument.

When a **CODE** value is active, *all radios in the system must use the same code value*. If the code value is not properly programmed, a Remote radio will not synchronize with the Master.

**CAUTION:** Record the **CODE** value and store it in a safe place. If the code is later forgotten, and a unit is to be added to the system, all radios in the network must be set to **NONE** and then reprogrammed to a new value.

## **CSADDR [1–65000, NONE]**

### *Clock-Synchronizing Master Address*

Used to specify the network address of a “Clock-Sync” Master station to which this station will be synchronized. Also see [“ADDR \[1–65000\]” on Page 29](#) and [“Co-Located and Close-Proximity Masters” on Page 63](#) for further details.

## **CTS [0–255]**

### *Clear-to-Send Delay*

The **CTS** (clear-to-send) command sets or displays the timer value associated with the CTS line response. The command parameter ranges from 0 to 255 milliseconds.

For DCE operation, the timer specifies how long to wait after the RTS line goes high before asserting the CTS line. A timer value of zero means that the CTS line will be asserted immediately following the assertion of RTS.



For CTS Key operation (see the **DEVICE** command), the timer specifies how long to wait after asserting the CTS line before sending data out the DATA port. A timer value of zero means that data will be sent out the data port without imposing a key-up delay. (Other delays may be in effect from other radio operating parameters.)

## **CTSHOLD [0–60000]**

### *Clear-to-Send Hold Time*

Used in **DEVICE CTS KEY** mode, this command sets the amount of time in milliseconds that CTS remains present following transmission of the last character out the RXD pin of the DATA port. This “hold time” can be used to prevent squelch tail data corruption when communicating with other radios.

The **CTSHOLD** setting can range from 0 to 60000 (i.e., 60 seconds). The default value is 0, which means that CTS will drop immediately after the last character is transmitted. If the command is entered when the radio is in **DEVICE DCE** mode, the response **CTSHOLD N/A** will be displayed.

## **DEVICE [DCE, CTS KEY]**

### *Radio-MODEM Behavior*

The **DEVICE** command sets or displays the device behavior of the radio. The command parameter is either **DCE** or **CTS KEY**.

The default selection is **DCE**. In this mode, CTS will go high following RTS, subject to the CTS programmable delay time. Keying is stimulated by the input of characters at the data port. Hardware flow control is implemented by dropping the CTS line if data arrives faster than it can be transmitted.

If **CTS KEY** is selected, the radio is assumed to be controlling another radio, such as in a repeater or tail-end link system. The RTS line is ignored and the CTS line is used as a keyline control for the other radio. CTS is asserted immediately after the receipt of RF data, but data will not be sent out the DATA port until after the CTS programmable delay time has expired. (This gives the other radio time to key.)

Following transmission of the last byte of data, CTS will remain asserted for the duration specified by the **CTSHOLD** command. **CTSHOLD** should be set sufficiently high.

## **DLINK [xxxxx/ON/OFF]**

### *InSite Diagnostics Link Support*

**DLINK ON** enables use of *Diagnostic Link* mode and establishes it as the default protocol on the RJ-11 DIAG port. *Diagnostic Link* mode is a special protocol used to support Network-Wide Diagnostics. **DLINK** must be set to **ON** to support connection to *InSite* or to support chained diagnostics between radio networks even while the radio is in sleep mode. **DLINK OFF** disables this feature. The default setting is **ON**.

The following **DLINK** baud rates selections are supported:

- 1200
- 4800
- 9600
- 19200 (default)
- 38400
- 57600
- 115200

Example: **DLINK 4800** sets the RJ-11 DIAG port to operate at 4800 bps when diagnostics is closed. This setting will not affect the port's autobaud operation. Use only of **DLINK ON**, will enable the use 19200 or the most recently programmed value. The default is **DLINK 19200** and **DLINK ON**.

**NOTE 1:** The same baud rate must be entered into the InSite Equipment List's **BAUD** field.

**NOTE 2:** The DLINK rate must match the rate of any connected device to the diagnostic port. This may be either another MDS radio's diagnostic port, InSite computer, or another data link device that eventually connects to the InSite computer.

## DKEY

*Turn Off Radio Transmitter's Test Signal*

Disables the transmitter when it is keyed. See also **KEY** command.

## DTYPE [NODE/ROOT]

*Network Diagnostics Mode*

The **DTYPE** command specifies the radio's operational characteristics for network-wide diagnostics. The transceiver uses the following types:

- **NODE**—The most common setting, and the default. This is the basic system radio device-type. Typically, the radio network is comprised of nodes and one root. Intrusive diagnostics can originate from any node. However, non-intrusive diagnostics can only be conducted from the root node.
- **ROOT**—Always one, and only one, per network (including units associated through Extension units.) The root is the focal point of network-wide diagnostics information. Intrusive diagnostics can originate from any radio, including the root. However, the root is the *only* radio through which non-intrusive diagnostics can be conducted.

## FEC [ON, OFF]

*Forward Error Correction*

This command is used to view the FEC setting, or turn it on or off. The default setting is **FEC ON**. (It needs to be turned off when throughputs exceed 57,600 bps.) FEC is set at the Master and is automatically passed on to all Remotes in a network.

Setting FEC to **ON** improves sensitivity at the cost of reduced throughput. Typical SCADA/telemetry applications use low data rates and, as such, the FEC setting is normally transparent to them.



## HOPTIME [7, 28]

### *Radio Transmitter Hop Timing*

The **HOPTIME** command is used to set or display the hop-time setting. The command is a digit corresponding to the hop-time setting in milliseconds. The default **HOPTIME** setting is **7**. A setting of **28** must be used when throughputs exceed 57,600 bps and is recommended when data transmission sizes exceed 256 bytes.

Changes to the **HOPTIME** setting may only be made at the Master radio. (This is because the Master radio establishes the hop-time setting for the entire network.) At Remote radios, the hop-time setting may be read when the radio is in synchronization with the Master, but it cannot be changed.

## INIT

### *Initialize; Restore to Factory Defaults*

The **INIT** command is used to reset the radio's operating parameters to the factory defaults listed in [Table 12 on Page 34](#). This may be helpful when trying to resolve configuration problems that resulted from the entry of one or more improper command settings. If you are unsure of which command setting caused the problem, this command allows you to get back to a known working state.

**NOTE:** Caution should be exercised when using the **INIT** command on radios in a system employing the Store-and-Forward feature. Settings relating to the use of Extension services will be lost and will need to be re-entered. Record the settings for **XADDR**, **XPRI** and **XMAP** before using the **INIT** command.

## SPECIAL

**NOTE:** Installing firmware of Revision 3.0 or later into a radio with Revisions 1.x firmware will preserve the radio's compatibility with other radios running Revision 1.x firmware. If updating the radio's firmware is part of a system-wide upgrade, the last step should be to use the **INIT** command at the Master station. Use of the **INIT** command causes the changes shown in [Table 12](#) to be applied.

**Table 12. INIT Command Generated Defaults**

Parameter	Default Setting	Corresponding Command
<i>For ALL radios</i>		
Alarm Mask	FFFF FFFF	AMASK
Alarm Output Sense	RS-232 High (+5.0 Vdc)	ASENSE
Device Operation	DCE	DEVICE DCE
DATA Interface Port	<ul style="list-style-type: none"> <li>• 9600 baud</li> <li>• 8 data bits</li> <li>• none (no parity)</li> <li>• 1 stop bit</li> </ul>	BAUD 9600 8N1
Data Port Setting	RS/EIA-232	PORT RS232
CTS Delay	0 (CTS is continuously asserted)	CTS 0
CTS Hold-Time	0	CTSHOLD 0



**Table 12. INIT Command Generated Defaults (Continued)**

Parameter	Default Setting	Corresponding Command
LED Operation	OFF	LED
Low-Power Mode Hold	0	LPMHOLD
RX Time-Out-Timer	None/Disable	RXTOT
RF Output Power	30 dBm (1 watt)	PWR 30
Transmitter Test Frequency	915.000 MHz or 2436.0 MHz (Model dependent)	TX xxx
Receiver Test Frequency	915.000 MHz 2436.0 MHz (Model-dependent)	RX xxx
Sleep Mode	OFF	SLEEP OFF
Primary Extension Radio Address	0 (Master)	XPRI 0
Synchronization Source Map	None	XMAP 0
Extended Address	0	XADDR 0
<i>For MASTER radios</i>		
AT Command Support	OFF	AT
Buffer Mode	OFF	BUFF OFF
Forward Error Correction	ON	FEC ON
Hop-Time	7 ms	HOPTIME 7
Low-Power Mode	0 (Off)	LPM
Skipped Frequencies	None (radio will hop across all frequencies)	SKIP NONE
Retry Count	10 (max. of 10 repeats for ARQ)	RETRY 10
Repeat Count	3 (downstream repeats)	REPEAT 3

## HREV

*Hardware Revision*

Shows the hardware revision of the radio.

## KEY

*Turn On Radio Transmitter Test Signal*

Enables the transmitter. (Radio must be in Setup mode.) See also **DKEY** command (**DKEY** *Details, Page 33*).



## LED [ON, OFF]

*Enable/Disable PCB LEDs*

**LED ON** enables/disables the PCB board mounted LEDs seen only with the transceiver's covers removed. **LED** is normally **OFF**, it may be useful to have them on for testing the radio with the covers removed. Note: the *external* LEDs will be dimmer if the **LED** function is left **ON**.

The **LED** command also affects the operation of the LEDs in the “Low-Power Mode” (**LPM**). When **LED** is **OFF**, the radio keeps the PWR and SYNC LEDs extinguished.

## LPM [1, 0]

*Low-Power Mode—Masters Only*

This feature trades increased latency to gain power savings. Low-power mode (LPM) automatically saves power at a Remote by instructing the Remote to shutdown for large periods of time in between **SYNC** messages. Master transmissions are automatically blocked while the Remotes are asleep. Note, both Masters and Remotes are adaptive and will suppress a normal sleep interval if data transmission or reception is in progress.

- **LPM 1** at the Master enables low-power mode network-wide; all Remotes pick it up and start saving power by automatically sleeping.  
**LPM 1** can work in conjunction with the AT dialing feature. The dialed unit will be forced awake; all others will sleep.
- **LPM 0** at the Master to disable low-power mode (Default setting).

The **SLEEP** command must be enabled for LPM to function. Further, when you enable LPM, the LEDs on the Remote radio dim even though the LPM function is not properly enabled by turning on **SLEEP**. For more information, see “*Low-Power Mode (LPM)—Master Enabled*” on Page 60, and “*Low-Power Mode versus Remote's Sleep Mode*” on Page 62.

## LPMHOLD [0–1000]

*Low-Power Mode Sleep Time*

Used to give an RTU time (0-1000 ms) to respond before the radio goes to sleep. Value determines how long to suppress auto-sleep following reception of the last character sent out of the RXD serial data port.

**NOTE:** Any values entered will be rounded to the nearest multiple of 4 ms.

To verify the exact hold time, enter **LPMHOLD**, the response will give you the value currently being used.

## MODE [M, R, X]

*Radio Operating Mode*

The **MODE** command sets or displays the operating mode of the radio. A Master radio is set by **MODE M**; a Remote set by **MODE R**, and an Extension is set by **MODE X**.



All units default to Remotes; other modes must be specifically programmed with the **MODE** command.

If **MODE X** is used, the **MODE X** radio should be programmed with an Extended Address (**XADDR**). Units that need to hear this **MODE X** radio must be programmed with an appropriate **XPRI** and/or **XMAP** value.

### **MRSSI [NONE, -40...-90]**

*Minimum RSSI for Mobile Operation*

The **MRSSI** command sets or displays the minimum RSSI level (dBm) of a Master station's signal to maintain synchronization. When the Master's signal falls below this level, the Remote will attempt to resynchronize with the next Master it can hear within the same network—same Network Address (**ADDR**)—and, meets the MRSSI level. See [“Mobile Operation Support” on Page 62](#) for additional information.

### **OT [ON, OFF]**

*Output Trigger*

The “output trigger” feature sets up a 1-second default delay on delivery of RXD serial data, however, a receipt of RTS causes cancellation of timer followed by immediate data delivery.

Hierarchy Rules:

- if **OT** = ON, RTS always cancels data delay and outputs immediately
- if **OT** = ON, **DEVICE** = DCE, and **RXD** = 0, data delay is 1 second or until RTS
- if **DEVICE** = DCE, and **RXD** = N, data delay is N ms
- if **DEVICE** = CTS KEY, and **CTS** = N, data delay is N ms or until RTS
- if **DEVICE** = CTS KEY overrides **RXD**, **RXD** overrides **OT** default.

### **OWM [xxxxx]**

*“Owner’s Message”*

The **OWM** command sets or displays an optional owner's message, such as the system name. The entry can contain up to 30 characters.

### **OWN [xxxxx]**

*“Owner’s Name”*

The **OWN** command sets or displays an optional owner's name, such as the site name. The entry can contain up to 30 characters.

### **PORT [RS232, RS485]**

*Data Interface Port Signaling Standard*

Select or identify the current data port (DATA connector) interface signaling mode: **RS232** or **RS485**. This is the port through which the payload data will



pass. Pin descriptions for EIA-232 are on [page 69](#) and EIA-485 can be found on [page 71](#).

## **PWR [20–30]**

### *Radio Transmitter Power Level*

This command displays or sets the desired RF power output of the radio. The **PWR** command parameter is specified in dBm and can be adjusted in 1 dBm steps. The default setting is 30 dBm (1 watt) for the 900 MHz model and 27 dBm (0.5 watt) for the 2400 MHz model. To read the actual (measured) power output of the radio, use the **SHOW PWR** command.

In the USA, maximum allowable power is governed by FCC limits on Effective Isotropic Radiated Power output (EIRP). The EIRP limit of +36 dBm on the 900 and 2400 MHz band, means that any user with a net antenna gain greater than 6 dBi on the 900 MHz band, or 9 dBi on the 2400 MHz band, must decrease the **PWR** setting accordingly. “[How Much Output Power Can be Used?](#)” on [Page 12](#) contains a detailed discussion of this topic.

## **REPEAT [0–10]**

### *Downstream Repeat Transmission Count*

The **REPEAT** command affects “downstream” data. The command causes a Master or Extension to always repeat transmissions for the specified number of times (range is 0 to 10; default selection is 3). Unlike the **RETRY** command, there is no acknowledgment that a message has been received.

Use the **REPEAT** command without a value to display the current setting.

## **RETRY [0–10]**

### *Upstream Repeat Transmission Count*

The **RETRY** command affects upstream data. The command selects, or displays, the maximum number of times (0 to 10) that a Remote radio will re-transmit data. The default setting is 10.

This command is associated with ARQ (Automatic Repeat Request) operation of the radio and is intended for use in areas with heavy radio interference.

When the **RETRY** command is issued without parameters, the maximum retransmission count is shown. A value of 0 represents no retries, while values of 1 or greater successively improve the chance of data delivery in spectrally harsh environments (at the expense of possibly increased latency). The **RETRY** value is only settable at the Master. It is readable by a synchronized Remote.

## **RSSI**

### *Received Signal Strength Indicator*

This command displays the radio’s Received Signal Strength Indication in dBm (decibels relative to 1 mW). The output can range from –40 dBm to –120 dBm. Command availability and results depend on the mode of operation (Master or Remote). The closer to 0 dBm, the stronger the signal, thus a reading of –70 dBm is stronger than –80 dBm.

For a Remote radio, under normal operation, RSSI is based on the average signal strength of the SYNC message received in each of the eight frequency zones. (RSSI is sampled each time a SYNC message is received.) When using the RSSI reading to align a directional antenna, it is important to make changes slowly so that the RSSI reading will provide meaningful results. It will take several seconds to indicate a change in signal level. The radio stays in RSSI mode until **[ENTER]** is pressed.

For a Master radio, under normal operation, entering the RSSI command causes the response **NOT AVAILABLE** to be returned. This is because a Master is normally receiving signals from several Remote stations and an RSSI reading would be continually changing. The only exception is when the **SETUP** command has been asserted. This disables hopping and allows reading a “raw” RSSI signal level in real time from a Master or Remote radio.

**NOTE 1:** RSSI readings will not accurately indicate signals stronger than -40 dBm.

**NOTE 2:** RSSI works for Dependent Masters. Command displays “NOT AVAILABLE” if the Dependent Master is not synchronized.

## RTU [ON, OFF, 0-80]

### *Remote Terminal Unit Simulator*

This command re-enables or disables the radio’s internal RTU simulator, which runs with GE MDS proprietary polling programs (poll.exe and rsim.exe). The internal RTU simulator is available whenever a radio has diagnostics enabled. This command also sets the RTU address to which the radio will respond.

The internal RTU can be used for testing system payload data or pseudo bit error rate (BER) testing. It can be helpful in isolating a problem to either the external RTU or the radio. The default RTU setting is **OFF**. To use this command in a polling environment for testing, refer to the *Network-wide Diagnostics Systems Handbook* (P/N: 05-3467A01).

## RX [xxxx]

### *Radio Receive Test Frequency*

This command sets or displays the test receive frequency used in place of hopping when the radio is in **SETUP** mode. The test receive frequency can be reprogrammed to any value between 902.200 MHz and 927.800 MHz, inclusive. The factory default setting is 915.000 MHz.

For the 2400 MHz radios, the test frequency can be programmed to any frequency between 2400.6 MHz and 2482.0 MHz. The default value is 2436.0 MHz.

## RXD [0–255]

### *RXD Delay*

Used to set a delay, in milliseconds, of RXD data to emulate a seamless mode with much lower latency in applications where retries are not required. Use a delay of twice the value of the **HOPTIME** period (See [page 34](#)).



Entering a **RXD ON** (0 ms default) or **RXD XX** will enable the function.  
Entering **RXD OFF** will disable the function and erase any stored value.

## **RXTOT [NONE, 0–1440]**

*Receive Data Timeout-Timer*

This command sets or displays the amount of time (in minutes) to wait for the next received data packet before issuing a receiver time-out alarm. The default setting is **NONE**.

## **SAF [ON, OFF]**

*Store-and-Forward Services Support*

This command enables/disables the operation of the Store-and-Forward services. It can be set only at the network's Master station, but will effect all radios in the associated network. The default setting is **OFF**. See related commands: "**XADDR [0–31]**" on Page 44, "**XPRI [0–31]**" on Page 44, and "**XMAP [00000000-FFFFFFFF]**" on Page 44.

## **SETUP**

*Setup Radio Test*

This command sets up the transceiver for checking antenna SWR or transmitter power with external measuring equipment. Do not use this mode during normal operation.

When the **SETUP** command is entered, the prompt changes to **SETUP>**, and:

- Hopping is disabled.
- Synthesizer frequencies are reset to the test frequencies specified by the **TX** and **RX** commands described earlier.
- The radio can be keyed using the **KEY** command. **DKEY** is used to unkey the radio. (If the radio is left in a keyed state it is automatically unkeyed after 10 minutes.)
- The **RSSI** is sampled in a raw, continuous fashion regardless of whether the unit is a Master or a Remote.

Entering **Q** or **QUIT** returns the system to normal operation.

A timer keeps the Setup mode from accidentally leaving the system disabled. After 10 minutes the system behaves as if **Q** or **QUIT** had been entered, returning the unit to normal operation.

**NOTE:** TransNET uses a automatic level control in normal operation to keep transmit power constant over time. This facility is disabled in Setup mode. To test 1 Watt power output in Setup mode, the user must enter **PWR 30** followed by **KEY**. The power output will only be valid for the first couple of seconds.

## **SER**

*Radio Serial Number*

Displays the serial number of the radio.

## SHOW CON

### *Show Virtual Connection Status*

Shows virtual connection status established by the latest ATDT command sequence. (Works only with **AT ON**. See “[AT \[ON, OFF\]](#)” on Page 29)

If no connection is established, it displays **NONE**.

If a connection is active, it will display:

**<Master unit address> TO <Remote (“dialed”) unit address>**.

## SHOW PWR

### *Show Measured RF Transmit Power*

The **SHOW PWR** command displays the actual (measured) RF power output in dBm. Unlike the **PWR** command, this command shows the actual level being measured, not the programmed RF power setting.

## SHOW SYNC

### *Show Clock-Synchronization Master Network Address*

When used at a Remote station, this command will display **Extended Address** and **Unit Address** of the Master or Extension radio to which the Remote is synchronized. The network depth at the Remote, defined as the number of downstream links from the Master, is displayed in parentheses.

**SHOW SYNC** works for Dependent Masters. A value of zero (0) means the station is a Master synchronized to a Clock-Sync Master. The **SHOW SYNC** command will display an asterisk (\*) after depth value if the radio is operating with co-located Masters.

## SKIP [NONE, 1...8]

### *Skip Radio Operating Zones*

This command sets or displays which, if any, of the eight zones will be skipped from the radio’s hopping sequence. Skipping zones is one way of dealing with constant interference on one or more frequencies in the radio’s operating band. See “[A Word About Radio Interference](#)” on Page 8 for more information on dealing with interference.

Tables 13, 14, 15 and 16 show the frequency range covered by each zone. The command parameter is either the keyword **NONE** or an undelimited string of up to four digits where each digit 1...8 represents a corresponding zone to skip. (For zone parameter input, the digits can appear in any order and can be optionally separated by a blank space.) The **SKIP** command is display-only at Remote radios. (Remotes must be synchronized with the Master radio to display the skip status.)

In the USA, a maximum of *four* zones may be skipped for TransNET 900 and a maximum of *three* zones may be skipped for TransNET 2400. Check the regulatory requirements for your region. The **SKIP** function may not be permitted in your country and the radio will not respond to the **SKIP** command.

**Table 13. 900 MHz Frequency Skip Zones**

ZONE 1	ZONE 2	ZONE 3	ZONE 4	ZONE 5	ZONE 6	ZONE 7	ZONE 8
902.2 to 905.2	905.4 to 908.4	908.6 to 911.6	911.8 to 914.8	915.0 to 918.0	918.2 to 921.2	921.4 to 924.4	924.6 to 927.6

**Table 14. 2400 MHz, Band A, Frequency Skip Zones**

ZONE 1	ZONE 2	ZONE 3	ZONE 4	ZONE 5	ZONE 6	ZONE 7	ZONE 8
2401.6 to 2404.6	2404.8 to 2407.8	2408.0 to 2411.0	2411.2 to 2414.2	2414.4 to 2417.	2417.6 to 2420.6	2420.8 to 2423.8	2424.0 to 2427.0

**Table 15. 2400 MHz, Band B, Frequency Skip Zones**

ZONE 1	ZONE 2	ZONE 3	ZONE 4	ZONE 5	ZONE 6	ZONE 7	ZONE 8
2427.2 to 2430.2	2430.4 to 2433.4	2433.6 to 2436.6	2436.80 to 2439.8	2440.0 to 2443.0	2443.2 to 2446.2	2446.4 to 2449.4	2449.6 to 2452.6

**Table 16. 2400 MHz, Band C, Frequency Skip Zones**

ZONE 1	ZONE 2	ZONE 3	ZONE 4	ZONE 5	ZONE 6	ZONE 7	ZONE 8
2452.8 to 2455.8	2456.0 to 2459.0	2459.2 to 2462.2	2462.4 to 2465.4	2465.6 to 2468.6	2468.8 to 2471.8	2472.0 to 2475.0	2475.2 to 2478.2

## SLEEP [ON, OFF]

*Transceiver Sleep—Remotes Only*

This command is used to set or display the radio's Sleep Mode setting. The default setting is **SLEEP OFF**. When this setting is **ON** (enabled) the Low-Power, or RTU-forced Sleep Mode, can be used. This function cannot be turned on for a Master or Extension radio unless the unit is in the Low-Power Mode. See [“Using the Radio's Sleep Mode \(Remote Units Only\)” on Page 59](#) and [“Low-Power Mode versus Remote's Sleep Mode” on Page 62](#) for more information.

## SREV

*Firmware Revision Level*

This command displays the version of the firmware currently loaded into the transceiver.

A display of **06-4040A01, 3.6.1** is an example of the firmware version identifier—part number followed by release/version number.

## STAT

### *Alarm Status*

This command is used to check the alarm status of the radio. If no alarms exist, the message **NO ALARMS PRESENT** is returned.

If an alarm does exist, a two-digit alarm code (00–31) is displayed and the event is identified as a “Major” or “Minor” alarm. A brief description of the event is also given.

If more than one alarm exists, the word **MORE** appears, and additional alarms may be viewed by pressing the **[ENTER]** key. Detailed descriptions of the alarm codes are provided in [Table 18 on Page 47](#).

## TEMP

### *Radio's Internal Temperature*

This command displays the internal temperature of the transceiver in degrees Celsius. (Note that the radio is specified to operate in an environment between –30° C and +60° C). This internal reading may be higher than the outside temperature by several degrees.

## TX [xxxx]

### *Radio Transmit Test Frequency*

This command sets or displays the test transmit frequency used in place of hopping whenever the radio is in Setup mode. The test transmit frequency for the 900 MHz radios can be reprogrammed to any value between 902.200 MHz and 927.800 MHz, inclusive. The factory default setting is 915.000 MHz.

For the 2400 MHz radios, the test frequency can be programmed to any frequency between 2400.6 MHz and 2482.0 MHz. The default value is 2436.0 MHz.

## UNIT [10000–65000]

### *Unit Address*

This command sets the unit addressing for network-wide diagnostics and AT-Command address. The unit address is factory programmed to the last four digits of the radio's serial number. If re-programmed in the field, the entry must consist of five digits between 10000 and 65000.



## **XADDR [0–31]**

### *Extended Address*

Used to display or program the Extended Address of this radio that will serve as a common address for the sub-network synchronized to this Master or Extension. This value can be listed in the **XPRI** parameter of associated Extension or Remote radios to allow them to synchronize to this radio. We recommend setting the Master to zero (0). It is easy to remember, and is the default address when the INIT command is used. (Programmed only in Master and Extension radios.)

## **XMAP [00000000-FFFFFFFF]**

### *Map of Extension Addresses*

XMAP is a 32-bit hex entry where the least significant bit represents XADDR 0 and the most significant bit represents XADDR 31. The full 32-bit hex value represents the entire list of extensions with which the radio will be allowed to communicate. (Pertains to Remotes and Extensions only.)

This parameter is easily programmed through the *MDS TransNET Configuration Software's* **Store-and-Forward Settings** panel.

## **XPRI [0–31]**

### *Primary Extended Address*

Will display or program the extended address of the primary radio with which this radio will attempt to synchronize and communicate. A setting of **NONE** allows the unit to synchronize with any Master or Extension in the **XMAP** list. (Parameter only meaningful for Remote or Extension units.)

## **XRSSI [NONE, -40...-120]**

### *Extension RSSI Level*

The **XRSSI** command is used to set the RSSI minimum signal level required to preserve synchronization with a non-primary Extension radio. This parameter will be ignored if **XPRI** is set to **NONE**.

## **ZONE CLEAR**

### *Clear Zone Statistics Log*

The **ZONE CLEAR** command clears the zone data for *all* zones in the Zone Data Log, resetting the count to 0. (Zone data is also cleared automatically upon reboot.)

## **ZONE DATA**

### *Read Zone Statistics Log*

The transceiver divides its frequency operating spectrum into eight 3.0 MHz-wide zones or sub-bands. (These are the same zones referenced by the **SKIP** command described earlier.) Data frame statistics are maintained for each zone to indicate the transmission quality of data through the network. This information is useful for identifying zones where significant interference exists.



Historical information on the quality of each zone can be accessed using the **ZONE DATA** command. The report shows you the number of data frames sent, the number received, and the number received with errors. If an excessive number of errors are seen in one or more frequency zones, it may indicate interference, and you should consider “skipping” those zones using the **SKIP** command (See “**SKIP [NONE, 1...8]**” on Page 41).

Note: If a frequency zone has been skipped, all counts for that zone will be zeros.

The **ZONE DATA** format is displayed as follows:

```
1:TX TOTAL 00000000
1:RX TOTAL 00000000
1:RX ERROR 00000000
x:
x:
8:TX TOTAL 00000000
8:RX TOTAL 00000000
8:RX ERROR 00000000
```

All data is based on payload packets. Incoming network data may be divided into multiple packets for over-the-air transfers. The number before the colon represents the zone. **TX TOTAL** is the transmit packet total. **RX TOTAL** is the receive packet total. **RX ERROR** is the total number of received packets with CRC errors. All zone data is reset with the **ZONE CLEAR** command.

## 7.0 TROUBLESHOOTING

Successful troubleshooting of the transceiver is not difficult, but requires a logical approach. It is best to begin troubleshooting at the Master station, as the rest of the system depends on the Master for polling instructions and synchronization data. If the Master station has problems, the operation of the entire network will be affected.

When communication problems are found, it is good practice to begin by checking the basics. All radios in the network must meet these basic requirements:

- Adequate and stable primary power
- An efficient and properly aligned antenna system
- Secure connections (RF, data & power)
- Proper programming of the radio’s operating parameters, especially Operating Mode (**MODE**), Network Address (**ADDR**), and interface Baud Rate (**BAUD**). For TransNET 2400 check the sub-band (**BAND**).
- The correct interface between the radio and the connected data equipment (proper cable wiring, data format and timing).
- In store-and-forward systems there are several areas that should be checked or evaluated:
  - Look for duplicate **XADDR** values on **MODE M** and **MODE X** radios. Duplicates will cause failures unless the radios are too far apart to hear each other.

- Check for errors in the synchronization qualifiers, **XPRI** and **XMAP**, on corresponding Remote radios.
- Verify **SAF** is enabled at the Master radio.

## 7.1 LED Indicators

The LED status indicators are an important troubleshooting tool and should be checked whenever a problem is suspected. [Table 17](#) describes the function of each status LED.

**Table 17. LED indicator descriptions**



Name	Description
<b>PWR</b>	<ul style="list-style-type: none"> <li>• Continuous—Power is applied to the radio; no problems detected</li> <li>• Flashing (5 times-per-second)—Fault indication. See <a href="#">“TROUBLE-SHOOTING” on Page 45</a>.</li> <li>• Off—Radio is unpowered or in Sleep mode</li> </ul>
<b>SYNC</b>	Continuous—Radio is receiving/sending synchronization frames On within 10 seconds of power-up under normal conditions
<b>TXD</b>	Transmit data activity on the DB-9 DATA interface connector
<b>RXD</b>	Receive data activity on the DB-9 DATA interface connector

## 7.2 Alarm Codes

When an alarm condition exists, the transceiver creates an alarm code. These codes can be very helpful in resolving many system difficulties.

### Checking for Alarms—STAT command

To check for the presence of alarms, enter **STAT**. If no alarms exist, the message **NO ALARMS PRESENT** appears at the top of the display.

If an alarm does exist, a two-digit alarm code (00–31) is displayed, and it is identified as a major or minor alarm. A brief description of the alarm is also given. Alarm codes and their meanings are listed in [Table 18](#).

If more than one alarm exists, the word **MORE** appears at the bottom of the screen; additional alarms can be viewed by pressing **[ENTER]**.

### Major Alarms versus Minor Alarms

Major alarms report serious conditions that generally indicate a hardware failure, or other abnormal condition that will prevent (or seriously hamper) further operation of the transceiver.

With the exception of alarm code 00 (network address not programmed), major alarms generally indicate the need for factory repair. Contact the factory for further assistance.

Minor alarms report conditions which, under most circumstances, will not prevent transceiver operation. This includes out-of-tolerance conditions, baud rate mismatches, etc. The cause of these alarms should be investigated and corrected to prevent system failure.

## Alarm Code Definitions

Table 18 contains a listing of all event codes that may be reported by the transceiver. Additional alarm codes may be used in future firmware releases or are used by the factory.

**Table 18. Alarm Codes**

Alarm Code	Alarm Type	Description
00	Major	The network address is not programmed.
01	Major	Improper firmware detected for this radio model.
04	Major	One or more of the programmable synthesizer loops is reporting an out-of-lock condition.
08	Major	The system is reporting that it has not been calibrated. Factory calibration is required for proper radio operation.
10	Major	The DSP was unable to properly program the system to the appropriate defaults. A hardware problem may exist.
12	Major	Receiver time-out alarm.
16	Minor	The unit address is not programmed.
17	Minor	A data parity fault has been detected on the DATA connector. This usually indicates a parity setting mismatch between the radio and the RTU.
18	Minor	A data framing error has been detected on the DATA connector. This may indicate a baud rate mismatch between the radio and the RTU.
29	Minor	RF output power fault detected. (Power differs by more than 2 dB from set level.) Often caused by high antenna system SWR. Check antenna, feedline and connectors.
30	Minor	The system is reporting an RSSI reading below -105 dBm.
31	Minor	The transceiver's internal temperature is approaching an out-of-tolerance condition. If the temperature drifts outside of the recommended operating range and the transceiver may fail.



## 7.3 Troubleshooting Chart

Table 19 provides suggestions for resolving system difficulties that may be experienced in the radio system. If problems persist, contact the factory for further assistance. Refer to the inside back cover of this guide for contact information.

**Table 19. Troubleshooting Guide**

Difficulty	Recommended System Checks
<b>Unit is inoperative</b>	<ul style="list-style-type: none"> <li>a. Check for the proper supply voltage at the power connector.</li> <li>b. The transceiver's internal fuse may have opened. Refer to <a href="#">Section 7.5</a> below for replacement instructions.</li> </ul>
<b>Interference is suspected</b>	<ul style="list-style-type: none"> <li>a. Verify that the system has a unique network address. Nearby systems with the same address will cause interference.</li> <li>b. Check for interference by locking out affected zone(s) using the <b>SKIP</b> command (<a href="#">Page 41</a>).</li> <li>c. If omnidirectional antennas are used on Remote stations, consider changing to directional antennas. This will often limit interference to and from other stations.</li> </ul>
<b>No synchronization with Master, or poor overall performance</b>	<ul style="list-style-type: none"> <li>a. Check for secure interface connections at the radio and the connected device.</li> <li>b. Check the antenna, feedline and connectors. Reflected power should be less than 10% of the forward power reading (SWR <math>\approx</math> 2:1 or lower).</li> <li>c. If the Remote radio is in synchronization, but performance is poor, check the received signal strength using the <b>RSSI</b> command (<a href="#">Page 38</a>). If <b>RSSI</b> is low, it may indicate antenna problems, or misalignment of directional antenna headings.</li> <li>d. Verify proper programming of system parameters: mode, network address, data interface baud rate, transmitter power, CTS delay, etc. For store-and-forward applications, also verify the following: <b>SAF</b> is <b>ON</b>; extended address is properly programmed at each extension; Remotes are using the proper values for <b>XPRI</b> and <b>XMAP</b>.</li> <li>e. Check for alarms using the <b>STAT</b> command (<a href="#">Page 43</a>)</li> </ul>
<b>BER is too high. Data throughput is spotty</b>	<ul style="list-style-type: none"> <li>a. The <b>RETRY</b> and <b>REPEAT</b> commands may be increased to deal with interference, or decreased to increase throughput and reduce latency.</li> <li>b. Try turning on <b>FEC</b>. <b>FEC</b> on gives some coding gain, but comes at the cost of reduced throughput.</li> </ul>
<b>Latency is too high</b>	<ul style="list-style-type: none"> <li>a. Reduce the <b>REPEAT</b> count.</li> <li>b. Turn <b>BUFF OFF</b>. <b>BUFF ON</b> ensures that no gaps occur in the data, but this comes at the cost of increased latency.</li> <li>c. Make sure <b>HOPTIME</b> is set to 7.</li> </ul>

## 7.4 Performing Network-Wide Remote Diagnostics

Diagnostics data from a Remote radio can be obtained by connecting a laptop or personal computer running *MDS InSite* diagnostics software (Version 6.6 or later) to any radio in the network.

**NOTE:** The diagnostics feature may not be available in all radios. The ability to query and configure a radio via Network-wide Diagnostics is based on the feature options purchased in the radio being polled.

If a PC is connected to any radio in the network, intrusive polling (polling which briefly interrupts payload data transmission) can be performed. To perform diagnostics without interrupting payload data transmission, connect the PC to a radio defined as the “root” radio. A radio is defined as a root radio using the **DTYPE ROOT** command locally, at the radio.

A complete explanation of Remote diagnostics can be found in the *Network-Wide Diagnostics System Handbook* (P/N 05-3467A01).

**Table 20. Network-Wide Diagnostics Commands**

Command	Description
<b>DLINK [xxxxx/ON/OFF]</b> <i>Details, Page 32</i>	Set baud rate of diagnostics link
<b>DTYPE [NODE/ROOT]</b> <i>Details, Page 33</i>	Set radio's operational characteristics for network-wide diagnostics

1. Program one radio in the network as the root radio by entering the **DTYPE ROOT** command at the radio.
2. At the root radio, use the **DLINK ON** and **DLINK [baud rate]** commands to configure the diagnostic link protocol on the RJ-11 port.
3. Program all other radios in the network as nodes by entering the **DTYPE NODE** command at each radio.
4. Use the **DLINK ON** and **DLINK [baud rate]** commands to configure the diagnostic link protocol on the RJ-11 port of each node radio.
5. Connect a PC on which *MDS InSite* software is installed to the root radio, or to one of the nodes, at the radio's diagnostics port.

To connect a PC to the radio's DIAG port, an RJ-11 to DB-9 adapter (P/N 03-3246A01) is required. If desired, an adapter cable may be constructed from scratch, using the information shown in [Figure 21 on Page 69](#).

6. Launch the MDS InSite application at the PC. (Refer to the InSite user's manual for details.)

## 7.5 Internal Fuse Replacement

The radio is protected by an internal fuse. This fuse can be blown by an over-voltage transient or an internal failure. Follow the procedure below to remove and replace the fuse:

1. Disconnect the primary power cable and all other connections to the unit.
2. Place the radio on its back and remove the four Phillips screws at the corners of the bottom cover.
3. Carefully separate the top and bottom covers. There is a flat ribbon cable between the top cover's LED panel and the motherboard. You do *not* need to disconnect the ribbon cable.
4. Locate the fuse holder assembly behind the power connector. (See [Figure 16](#)).
5. Loosen the fuse from the holder using a very small flat-bladed screwdriver, then use a small pair of needle-nose pliers to pull the fuse straight up and out of the holder.
6. Use an ohmmeter or other continuity tester to verify that the fuse is blown.
7. Install a new fuse by reversing the process.  
Replacement fuse: Littelfuse #0454002; 452 Series, 2 Amp SMF Slo-Blo fuse (Part No. 29-1784A03).
8. Re-install the covers, interface cables and check the radio for proper operation.

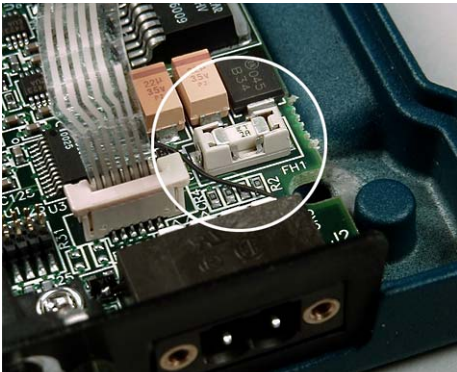

**Figure 16.**  
Internal Fuse and Holder  
Assembly Location

## 8.0 RADIO FIRMWARE UPGRADES

From time to time, the factory releases new firmware for its radio products. This file can be installed in existing radios to take advantage of engineering improvements or additional features.

### 8.1 Obtaining New Firmware

The latest firmware for each radio type may be obtained free from our Web site at:

[www.gemds.com](http://www.gemds.com)

Firmware is also available on disks from the factory that are bundled with an installation utility for transferring the firmware file on the disk to the radio.

#### Saving a Web Site Firmware File Onto Your PC

Firmware upgrades are distributed as a plain-text (ASCII) file with a “.S28” extension. Browse the factory web site to find the desired “.S28” file for your radio. When you have found your selection, use the right mouse button to select a path on your computer on which to save the file. (If this isn’t done, your browser may display the firmware file contents as text on the screen instead of downloading it to your local hard drive.)

After the “.S28” file has been saved to your computer, you may use either *MDS TransNET Configuration Software* or *MDS Radio Software Upgrade programs* to install this firmware in your radios.

### 8.2 Installing Firmware Into Your Radio

1. Connect the PC to the radio’s DIAG port using an RJ-11 to DB-9 Adapter Cable (Part No. 03-3246A01). If desired, a cable can be fabricated from the information shown in [Figure 21 on Page 69](#).
2. Start the *MDS TransNET Configuration Software*. Open diagnostics port to the radio. The program will automatically read the radio’s profile.
3. From the **File** menu, select **Radio Firmware Upgrade** and follow the prompts to install the new firmware into the radio. Do not press the **Cancel** button once the installation has started or it will leave the radio without any code. When the installation is complete, another radio may be connected to your PC and programmed.

**NOTE:** If a firmware installation fails, the radio is left unprogrammed and inoperative. This is indicated by the PWR LED flashing slowly (1 second on/1 second off). This condition is only likely to occur if there is a power failure to the computer or radio during the installation process. The installation should be attempted again.

## 9.0 OPERATING PRINCIPLES AND CONFIGURATION

### 9.1 SAF Operation with Extension Radios

The Store-and-Forward (SAF) capability operates by dividing a network into a vertical hierarchy of two or more sub-networks. (See [Figure 5 on Page 4.](#)) Adjacent sub-networks are connected via Extension radios operating in “**MODE X**” which move data from one sub-network to the next one.

The Store-and-Forward implementation adheres to the general polling principles used in most multiple-address systems (MAS). Polls originate from the Master station, broadcast to *all* radios within the network, and travel hierarchically downward. All Remotes will hear the same message, but only one Remote will respond. Messages within a hierarchy only travel in one direction at a time.

Using SAF will cut the overall data throughput in half, however, multiple networks can be inter-connected with no additional loss in network throughput.

#### Simple Extended SAF Network

The following example depicts a two-level network utilizing a single Master (M) and an Extension (X) radio. See [Figure 17.](#)

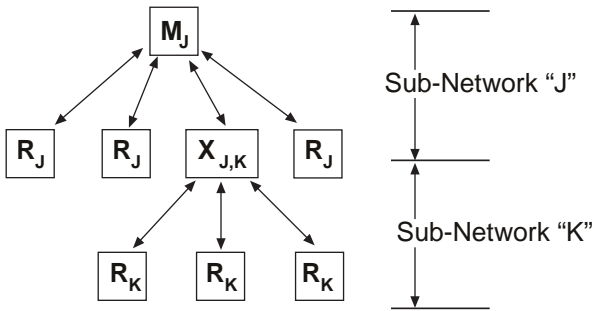

**Figure 17. Simple Extended SAF Network**  
*Networks: J and K*

In this network, messages directed to Remotes in the “K” sub-network, will be relayed through Extension radio  $X_{j,k}$  to the K-Remotes. Any response from a Remote in sub-network “K” will pass back through Extension radio  $X_{j,k}$  to the Master  $M_j$ . Radios in sub-network “J” operate on the same set of frequencies and sub-network “K” but with a different radio-frequency hopping pattern.

In the SAF operation, the Extension radios are set to **MODE X** ([Details Page 36](#)) and operate with a “dual personality”—50% of the time it serves as a Remote station and 50% of the time as a Master for sub-network Remotes.



## Extended SAF Network

Below is an example of a multilevel network utilizing two repeaters— $X_{J,K}$  and  $X_{K,L}$ . The example demonstrates the extensibility of the network. In this case, messages directed to Remotes in the sub-network L will be relayed through Extension radios  $X_{J,K}$  and  $X_{K,L}$ . Like the previous example, the Extension radios will split their operating time equally between their Master and Remote “personalities.” This multi-layered network can be extended indefinitely without degradation in throughput, beyond that initially incurred by placing the network in the SAF mode.

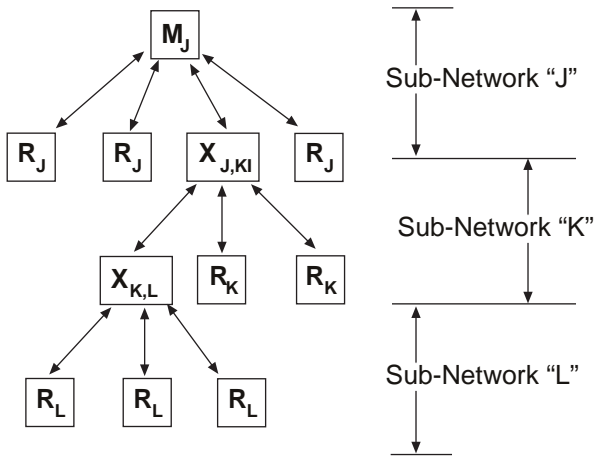

**Figure 18. Extended SAF Network**  
*Networks: J, K, L*

## Retransmission and ARQ Operation

Functionally, the sub-network side of an Extension behaves like a corresponding connection between a Master and a Remote.

When an Extension is using its “Master personality” it sends acknowledgments and performs unconditional retransmissions based on its **REPEAT** count.

When an Extension is using its “Remote personality,” acknowledgments are processed and retransmissions occur as needed, up to the number of times specified by the **RETRY** count value.

If data arrives from a new source prior to completion of retransmissions, it is considered to be a violation of the polling model protocol. The new data takes precedence over the old data, and the old data is lost. In such a situation, new data is likely to be corrupted as it will have some old data mixed in with it.

## SAF Configuration Example

Here is an outline for the configuration of a simple store-and-forward link.

1. **Mode X and M Radios**—Can have direct reports (Mode R radios) outside of the chain.
2. **Data (Payload)**—Travels from Master to Remote, and back from Remote to Master.
3. **Mode X and R Radios**—Extension links can be protected by mapping one or more fall-back paths in case of a failure. Add secondary extension addresses (XADDR) into the **XMAP** table. (See “[XMAP \[00000000-FFFFFFF\]](#)” on Page 44.)

For example, as shown in [Figure 19](#), Remote “D” could use Remote “C” as its extension primary, and Remote “B” (X ADDR = 1) as an alternative in case of a failure of Remote “C” (X ADDR = 2). This arrangement assumes a serviceable path between Remotes “D” and “B”, and requires Remote “D” to be programmed with XMAP = 2 to correspond with the XADDR address of Remote “B.”

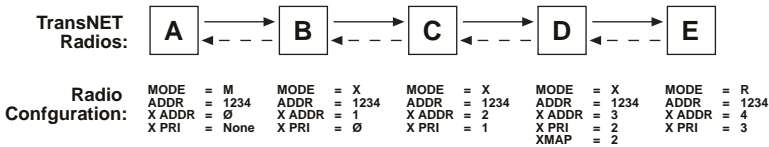

**Figure 19. SAF Configuration Example**

This configuration is easily arranged through the use of the **Extension Map** in the *MDS TransNET Configuration Software’s “Store-and-Forward Settings.”*

## 9.2 Synchronizing Network Units

The Master controls the synchronization for a given network for all modes. Setting the Master to **SAF ON** broadcasts a command from the Master to all radio units in the associated network either directly or through an Extension radio. This command puts *all radios in the entire system* in a special time-division duplexing mode that alternates between two timeslots. One time slot for data communications upstream and the second for downstream communications.

The Extensions are single radios which serve as bridges between adjacent sub-network levels. Extensions will undertake a “Remote personality” in one timeslot, and a “Master personality” in the alternate timeslot and provide communications with associated Remotes downstream. Extensions behave like two radios with their data ports tied together, first synchronizing with their upstream Master during their Remote personality period, and then providing synchronization signals to dependent Remotes downstream during its Master personality period.

All Remotes synchronize to a corresponding Master. This can be the “real Master” (the **MODE M** unit), or it can be a repeater “Extension” that derives synchronization from the “real Master.”

Payload polls/packets broadcast from the network Master will be repeated to all levels of the network, either directly to Remotes, or through network repeaters—the Extension station. The targeted Remote responds to the poll following the same path back to the Master.

## Synchronization Messages

Remotes acquire synchronization and configuration information via **SYNC** messages. They can synchronize to the Master (the **MODE M** unit) or to any valid Extension (a **MODE X** unit).

The Master will always transmit **SYNC** messages. An Extension will only start sending **SYNC** messages after synchronization is achieved with its Master.

The ability to synchronize to a given radio is further qualified by the sender’s Extended Address (**XADDR**) and by the receiver’s Synchronization Qualifiers (**XMAP**, **XPRI**, and **XRSSI**).

When a primary is specified (**XPRI** is 0...31), a radio will always attempt to find the primary first. If 30 seconds elapses and the primary is not found, then the radio attempts to synchronize with any non-primary radio in the **XMAP** list.

Once every 30 minutes, if a primary is defined, the radio will check its synchronization source. If the radio is synchronized to a unit other than the primary, then the current **RSSI** value is compared to the **XRSSI** value. If **RSSI** is less than **XRSSI** (or if **XRSSI** is **NONE**) the radio will force a loss-of-synchronization, and hunt for the primary again (as described in the previous paragraph).

By default, Extensions (and the Master) begin with **XADDR 0**. Synchronization qualifiers are set to **XMAP 0**, **XPRI 0**, and **XRSSI NONE**, respectively. This default configuration allows any radio to hear the Master. When an Extension is added, *the extended address of the Extension radio must be set to a unique value*. All Remotes that need to hear that extension can specify this either by designating the extension as the primary (**XPRI**), or by including it in their list of valid synchronization sources (**XMAP**).

## 9.3 Using AT Commands

A TransNET network may be configured to support protocols employing Hayes-Compatible modem commands through the radio’s AT Mode. In this mode, TransNET units can provide a communications replacement for dial-up modems where the RTUs and the protocol do not contain addressability, and the establishment of a direct-communications link is the only way to determine if the RTU has data ready to be sent. This requirement is common in many older SCADA systems which were developed for direct



connections where wire lines were the only communications link available at the time. Most of these older system implemented support for the AT commands needed in the host software, so TransNET units can be used without software modifications.

In this mode, the Master's DATA port is parsed for a subset of AT commands. (See *Supported Commands* below). When an **ATDT xxxxx** data sequence is detected, and **xxxxx** is a unit address of a radio in the network, the TransNET Master will establish a virtual link to that unit. It will remain in that state until either another **ATDT xxxxx** or **ATH** (hang-up/disconnect) is detected. (Note: Unaddressed Remotes in the network will not respond to user data. Data will only be exchanged between the equipment connected to the addressed Remote unit and the network or device connected to the Master's **DATA** port.

In order to use this mode, the command **AT ON** must be selected at the Master Radio. The acknowledgment to an ATDT command is simulated by the Master; there is no true verification that the far-end connection is valid.

Please consider the following additional information before using the AT commands:

- Radio commands and AT commands are independent with unique syntax and functional objectives.
- **ATDT** is not a radio command; it is part of the payload data input and follows the syntax for Hayes-compatible modems.
- TransNET commands are entered through the RJ11 DIAGNOSTIC port on Master and Remote radios. **AT ON** and **UNIT** are examples of TransNET commands.
- AT commands are only entered through the Master's DB-9 DATA port, and only when the TransNET command **AT ON** has been previously issued. The radio supports a *subset* of the Hayes-compatible modem AT set. Each command is *entered without spaces*, and always begins with **AT**, and *ends with a carriage return key press*.

## **Supported AT Commands**

Supported modem commands on the payload port are:

### **AT <attention>**

Replies with **OK** (Code 0).

### **ATDT [xxxxx] <dial>**

The command **xxxxx** represents 5-digit unit address with a leading zero (0) if applicable. This command replies with **CONNECT** (Code 1). Once connected, all characters are passed through until a **+++** is seen.

### **ATH <hang up> or +++**

This command replies with **OK** (Code 0) and deletes any virtual connection to the currently addressed Remote station.

### **ATV[x] <change verbosity>**

**x = 0**, means use numeric messages

**x = 1**, means use text messages (Default)

Replies with **OK** (Code 0)

### AT <command errors>

Replies with **ERROR** (Code 4)

### Characters with <no AT command>

Modem will echo characters in data stream but will be ignored until a second “AT” is seen at which time the modem closes the virtual connection.

### Operation Notes When AT Commands are ON

- Radios will not poll with the embedded RTU simulator unless a connection is established.
- Network-wide diagnostics are unaffected by the dialed unit connection status.
- The use of the TransNET **OT** command (Output Trigger) can be of benefit in some configurations. See “**OT [ON, OFF]**” on [Page 37](#) for configuration details.

## 9.4 Configuration Parameters for Store-and-Forward Services

The installation and configuration of a radio network with an Extension using SAF is straightforward with only a few unique parameters that need to be considered and set at each unit.

In every network there can be only one Master station. It will serve as the sole gateway to the outside world. The following three tables detail the parameters that will need to be set on each type of radio in the network.

- Network Master Radio—[Table 21 on Page 57](#)
- Extension Radio(s)—[Table 22 on Page 58](#)
- Remote Radio(s)—[Table 23 on Page 59](#)

**Table 21. Configuration Parameters for SAF Services**  
**Network Master Radio**

Parameter	Command	Description
Operating Mode	<b>MODE M</b> <a href="#">Details Page 36</a>	Sets the radio to serve as a Master.
Network Address	<b>ADDR</b> <a href="#">Details Page 29</a>	A number between 1 and 65,000 that will serve as a common network address.  All radios in the network use the same number.



**Table 21. Configuration Parameters for SAF Services  
Network Master Radio (Continued)**

Parameter	Command	Description
Extended Address	<b>XADDR</b> <i>Details Page 44</i>	A number between 0 and 31 that will serve as a common address for radios that synchronize directly to this Master.  Typically, the Master is set to zero (0).
Store-and-Forward Mode	<b>SAF ON</b> <i>Details Page 40</i>	Enables store-and-forward capability in the network.

**Table 22. Configuration Parameters for SAF Services  
Extension Radio(s)**

Parameter	Command	Description
Operating Mode	<b>MODE X</b> <i>Details Page 36</i>	Sets the radio to serve as an Extension.
Network Address	<b>ADDR</b> <i>Details Page 29</i>	A number between 1 and 65,000 that will serve as a common network address.  All radios in the network use the same number.
Extended Address	<b>XADDR</b> <i>Details Page 44</i>	A number between 0 and 31 that will serve as a common address for radios that synchronize directly to this Extension radio serving as Master for associated sub-network units.  Zero (0) is recommended for the Master station.
Primary Extended Address	<b>XPRI</b> <i>Details Page 44</i>	XADDR number of the primary or preferred radio with which this radio will synchronize.
Extension Map	<b>XMAP</b> <i>Details Page 44</i>	Lists all XADDR values with which this radio can synchronize, excluding the <b>XPRI</b> address.
Extension Received Signal Strength Indicator	<b>XRSSI</b> <i>Details Page 44</i>	The minimum RSSI level required to preserve synchronization with a non-primary radio. (Ineffective when <b>XPRI</b> is <b>NONE</b> )

**Table 23. Configuration Parameters for SAF Services  
Remote Radio(s)**

Parameter	Command	Description
Operating Mode	<b>MODE R</b> <i>Details Page 36</i>	Sets the radio to serve as a Remote station.
Network Address	<b>ADDR</b> <i>Details Page 29</i>	A number between 1 and 65,000 that will serve as a common network address or name.  Same number for all units in the same network.
Primary Extended Address	<b>XPRI</b> <i>Details Page 44</i>	XADDR number of the primary or preferred radio with which this radio will synchronize.
Extension Map	<b>XMAP</b> <i>Details Page 44</i>	Lists all XADDR values with which this radio can synchronize, excluding the <b>XPRI</b> address.
Extension Received Signal Strength Indicator	<b>XRSSI</b> <i>Details Page 44</i>	The minimum RSSI level required to preserve synchronization with a non-primary radio. (Ineffective when <b>XPRI</b> is <b>NONE</b> )

## 9.5 Using the Radio's Sleep Mode (*Remote Units Only*)

In some installations, such as at solar-powered sites, it may be necessary to keep Remote transceivers' power consumption to an absolute minimum. This can be accomplished using the radio's Sleep Mode feature. Power consumption in the sleep mode will be less at higher voltages and more at lower voltages. Power in the Sleep Mode at 13.6 Vdc is approximately 3 mA.

Sleep Mode can be enabled under RTU control by asserting a ground (or EIA/RS-232 low) on Pin 4 of the radio's DATA connector. All normal functions are suspended until it is awakened. The radio stays in Sleep Mode until a built-in one-minute timer "awakens" it for resynchronization, or the low is removed from Pin 4.

When Pin 4 is opened (or an EIA/RS-232 high is asserted), the radio will be ready to receive data within 75 milliseconds or less. The radio can be awakened more often if desired, by your RTU.

**NOTE:** The **SLEEP** function must be set to **ON**; without this, a ground on Pin 4 will be ignored.

It is important to note that power consumption will increase somewhat as communication from the Master station degrades. This is because the radio will spend a greater period of time “awake” looking for synchronization messages from the Master radio.

In order for the radio to be controlled by Pin 4, the unit’s Sleep Mode must be enabled through the **SLEEP [ON, OFF]** command. See “[SLEEP \[ON, OFF\]](#)” on [Page 42](#) for more information.

**NOTE:** If **INTRUSIVE** polling is used in InSite NMS software, it is necessary to select **SLEEP MODE INHIBIT ON** from the **Polling Options** menu, on the **Network Wide Diagnostic Polling** screen.

## Sleep Mode Example

The following example describes Sleep Mode implementation in a typical system. Using this information, you should be able to configure a system that meets your own particular needs.

Suppose you need communications to each Remote site only once per hour. Program the RTU to raise an EIA/RS-232 line once each hour (DTR for example) and wait for a poll and response before lowering it again. Connect this line to Pin 4 of the radio’s DATA connector. This will allow each RTU to be polled once per hour, with a dramatic reduction in power consumption.

## 9.6 Low-Power Mode (LPM)—Master Enabled

The Low-Power Mode (LPM) puts Remote radios into a configuration similar to Sleep, but with some important distinctions. The most important difference is the radio will automatically go to sleep in this mode, regardless of the condition of Pin 4 of the DATA interface connector.

This feature trades increased latency to gain power savings. The low-power mode (LPM) automatically saves power at a Remote by instructing the Remote to shutdown for long periods of time between SYNC messages. Master transmissions are automatically blocked while the Remotes are asleep. Note, both Masters and Remotes are adaptive and will suppress a normal sleep interval until after the end of a current data transmission or reception.

### Setup Commands

These are the command options and their applications:

- **LPM 1** at the Master enables low-power mode network-wide; all Remotes pick it up and start saving power by automatically sleeping.  
**LPM 1** can work in conjunction with the AT dialing feature. The dialed unit will be forced awake; all others will sleep.
- **LPM 0** at the Master is used to disable low-power mode (LPM) (Default setting following an **INIT** or firmware upgrade.)

For **LPMHOLD 0** with **REPEAT 0** setting, a Remote with no data to send will consume about 1/4 of its normal power consumption. Note that the **SLEEP** command must be enabled for the LPM to function.



## Reading RSSI and Other Parameters with LPM Enabled

It may be desired to perform tests and review operational settings of a Remote radio which has been programmed to operate in the low-power mode. Follow the abbreviated procedure below to interact with the radio through a local computer.

- Disconnect the Remote’s antenna to force it to lose sync with the Master
- Power-down the radio
- Connect a computer running TransNET configuration software to the Remote’s DIAG(nostic) port.
- Power-up the radio
- Reconnect the antenna
- Measure the RSSI or review and change any parameters you desire

## Power Consumption Influence by HOPTIME and SAF Settings

Table 24 presents representative current consumption and data delay values for various settings of TransNET radios setup for Low Power Mode, LPM (See “LPM [1, 0]” on Page 36). It assumes the primary power voltage is 13.8 Vdc and the polling rate is minimized to yield best-case power consumption (current) values.

The more each RTU is polled and asked to transmit, the more current will be consumed. Therefore, these values are the lowest that can be expected. Power consumption (current) is inversely related to data delay as shown in the table. When a radio is sleeping (LPM) mode, it is also waiting longer to deliver the payload data.

**Table 24. Power Consumption versus Hoptime and SAF Settings**

HOPTIME	SAF	Current (ma)	Data Delay
7	OFF	16	350 ms
7	ON	10	780 ms
28	OFF	7	1620 ms
28	ON	4	3360 ms

Note, the Store-and-Forward setting has a significant effect on power consumption, as it effectively doubles the HOPTIME to support LPM services. For the most power-efficient operation, turn on **SAF** even if you are not using repeaters.



## 9.7 Low-Power Mode versus Remote’s Sleep Mode

The Low-Power Mode (LPM) puts Remote radios into an operational configuration similar to Sleep, but there are some important differences. Below is a comparison of the two modes.

**Table 25. Power-Conservation Modes Comparison**

	Sleep Mode	Low-Power Mode
<b>Features</b>	<ul style="list-style-type: none"> <li>• Manual control by connected equipment</li> <li>• Selective application of Sleep control</li> <li>• User determines length and frequency of sleep periods</li> </ul>	<ul style="list-style-type: none"> <li>• Automatic radio-controlled timing</li> <li>• Automatic sleep during absence of directed traffic</li> <li>• Network-wide implementation through Master station</li> </ul>
<b>Benefits</b>	<ul style="list-style-type: none"> <li>• Low latency</li> <li>• Low standby power, <math>\leq 3</math> mA at 13.6 Vdc</li> <li>• Greatest potential for power savings</li> </ul>	<ul style="list-style-type: none"> <li>• Less complicated implementation</li> <li>• Simple configuration</li> </ul>

## 9.8 Mobile Operation Support

### Introduction

Reliable mobile operation of Remotes is practical in areas covered by multiple Master Stations within the same network—Master stations with the same Network Address (**ADDR**). To make this type of service practical, the Remote must have several reliable Master stations with which to communicate.

A “reliable” Master is defined as one, which consistently matches, or exceeds, the Remote’s standard for Minimum RSSI (**MRSSI**).

Initially, the Remote will favor Masters with signal strengths 10 dB greater than the MRSSI threshold. This will allow for some signal degradation of the new Master as the Remote travels.

When the average signal level from the currently-associated Master falls below the user-defined **MRSSI** level, the Remote will become out-of-sync and seek an alternate Master with a reliable signal.

## Operational Influences—Hoptime & SAF

The synchronization period is influenced by two parameters' values—**HOPTIME** and **SAF** (Store-and-Forward). [Table 26](#) shows several configurations and the associated synchronization period value.

**Table 26. Synchronization Period versus Hoptime and SAF Settings**

Sync Period	Hoptime Value	SAF
441 ms	7	OFF
1.8 sec	28	OFF
3.5 sec	28	ON

## 9.9 MIRRORED BITS™ Protocol Support

TransNET radios are compatible with Schweitzer's Mirrored Bits MB8 protocol, provided complementary firmware (06-4045A01) is installed in *all* network radios. A detailed application guide (AG2003-07) is available from Schweitzer Engineering Labs Web site, [www.SELinc.com/aglist.htm](http://www.SELinc.com/aglist.htm), or from Microwave Data Systems' Web site at [www.microwavedata.com](http://www.microwavedata.com).

## 9.10 Seamless Mode Emulation

The **RXD** command *assumes* the payload message will be ready for transmission after the delay period has expired. If there is a chance the payload data may be delayed, it is recommended to use the **BUFF(er)** command to make sure the entire message is received before delivery is started. The **BUFF** command provides a highly-reliable seamless operating mode, but can be very slow to start, especially if it waits for the reception of long messages before passing on the message.

## 9.11 Full-Duplex Emulation

If your system design needs to support PTP or Point-to-Multipoint applications and your communications must appear to be full-duplex to the connected devices, set the Master to **CSADDR xxxxx** (where **xxxxx** is the Network Address (**ADDR**)). This will place the system in a time-division duplex mode (TDD). The radio system will appear to be full-duplex to the connected devices, but actually operates half-duplex over the radio link. Data is buffered by the transmitting side until it is its turn to transmit. Throughput will be approximately 1/2 of the DATA interface rate.

## 9.12 Co-Located and Close-Proximity Masters

If your requirements call for multiple TransNET networks at the same location, you need to ensure that interference between the systems is minimized to prevent overload that will diminish the performance of the radios. Traditionally, vertical separation of the antennas of co-located radios was required



in order to reduce the interference to the point where overload of one network by the other will not occur. The **CSADDR** command will provide relief from this antenna separation requirement by operating the networks in a TDD mode and ensuring that one Master cannot transmit while the other (or multiple others) are trying to receive a signal from a distant radio.

## Master Station Configuration

On all Masters for which you wish to synchronize transmissions, establish one Master as the “Clock-Sync Master by setting its **CSADDR** value to its own Network Address (**ADDR xxxxx**). Then, set all other dependent Masters **CSADDR** values to the Network Address (**ADDR**) of the Clock-Sync Master. Make sure that you use a different Network Address (**ADDR**) for each Master. This value will be used to identify all units associated with this Master’s network.

Note that all Masters must be set to the same **CSADDR** setting, but only one where the **CSADDR** matches its own **ADDR**; this is the Clock-Sync Master.

**CSADDR = ADDR**—Unit serving as a Clock-Sync Master

**CSADDR ≠ ADDR**—Unit serves as a Dependent Master (Clock Slave)

**CSADDR = NONE**—Co-located Master feature disabled (default)

**HOPTIME**, **FEC** and **SAF** values are provided by the Clock-Sync Master to all dependent units.

**NOTE:** If a Dependent Master station is unable to find the Clock-Sync Master station, it will not be able to operate properly and the associated network will be out-of-service.

## Antenna System for Co-Located Master Stations

Using this TDD (Clock-Sync) mode will prevent any two Masters from transmitting and receiving at the same time and greatly reduce the antenna separation requirements to near zero. Under this arrangement, the antennas of co-located Masters may be placed a few feet (less than a meter) apart horizontally, or just above or below vertically with no ill effects. There are two common antenna system arrangements:

### *Sharing a Common Antenna System*

It is possible to share an antenna between multiple Masters using standard power dividers, as long as the extra loss associated with these devices is taken into account in your RF budgeting process. Masters in this configuration must be operating with Clock-Sync (**CSADDR**) enabled.

Ideally, co-located Masters should use separate antennas. They can share an antenna only if isolation is sufficient. If sufficient isolation is not guaranteed, degraded performance will result. For example, the two Master stations shown in [Figure 20 on Page 65](#) are connected to a common antenna system. They use a power-divider that will result in a signal loss of 3 dB, or one-half power level, on both transmit and receive signals.

The power divider, such as a Mini-Circuits ZAPD-1 or similar product,

must be capable of handling 1 Watt and have >25 dB isolation between TX ports. In some cases, up to 35 dB of isolation is required. Isolation is improved by adding attenuators between the TransNET radios and the splitters.

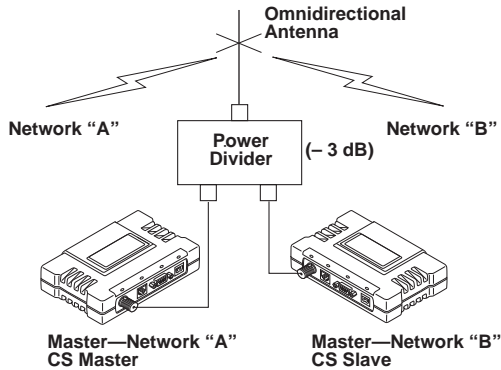

Figure 20. Co-Located Masters Sharing an Antenna

### 9.13 Security

Today, the operation and management of an enterprise is becoming increasingly dependent on electronic information flow. An accompanying concern becomes the security of the communication infrastructure and the security of the data itself. GE MDS takes this matter seriously, and provides several means for protecting the data carried over its wireless products.

The radio addresses this issue primarily through the use of the following items:

1. **A proprietary modem/data link layer**—Data signals are processed using code and hardware specifically designed by GE MDS.
2. **A unique Network Address**—This provides a unique identifier for each radio in a network. A radio is not addressable unless this unique code is included in the data string.
3. **An optional encryption value (code)**—Setting an encryption code requires the use of the **CODE** command. This command scrambles the radio's hop pattern and encrypts payload data content. A radio requires the correct Network Address (**ADDR**) and **CODE** value in order to synchronize. When the **CODE** command is used, the same value must be programmed into all radios in the network. See "[CODE \[NONE, 1...255\]](#)" on Page 31 for more details.

The effective combination of **CODE** and **ADDR** discourage the use of an exhaustive search to gain access to a system.



The items described above provide sufficient security for a typical MAS system. For more highly-sensitive applications, system designers should consider employing application level encryption into their polling protocols to further protect their systems. Third party software tools are available for adding encryption, and these should be considered as part of any advanced encryption scheme.

## 10.0 TECHNICAL REFERENCE

### 10.1 Product Specifications—900 MHz

#### GENERAL

---

Frequency Hopping Range:	902–928 MHz, Subdivided into eight 3.2 MHz zones
Hop Pattern:	Based on network address
Frequency Stability:	±1.5 ppm
Half-Duplex Operation:	±1.6 MHz TX/RX split
Network Addresses:	65,000
Temperature Range:	–40° C to +70° C
Humidity:	<95% at +40° C; non-condensing
Primary Power:	13.8 Vdc, Nominal (6–30 Vdc range)
Current Draw (typical @ 30 dBm):	
Transmit:	510 mA @ 13.8 Vdc
Receive:	115 mA @ 13.8 Vdc
Sleep Mode:	≤ 3 mA @ 13.8 Vdc
Size:	5.30" W x 3.50" D x 1.40" H (135 W x 89 D x 36 H mm)
Weight:	1 Lb / 0.5 kg w/o brackets; 1.15 Lb / 0.52 kg w/brackets
Case:	Die-cast aluminum
Agency Approvals:	<ul style="list-style-type: none"> <li>• FCC Part 15.247 (E5MDS-EL805)</li> <li>• Industry Canada RSS-210 and RSS-139 (CAN 3738A 12122)</li> <li>• UL/CSA Class 1, Div. 2; Groups A, B, C and D hazardous locations</li> <li>• Contact the factory for information on availability of governmental approvals in other countries</li> </ul>
MTBF (Reliability):	Consult factory for on-file data

#### DATA CHARACTERISTICS (DB-9 Data Port)

---

Data Interface:	RS-232/422/485
Interface Connector:	DB-9 female

---



Data Rate:	300, 600, 1200, 1800, 2400, 4800, 9600, 19200, 38400, 57600, 115200 bps asynchronous
Data Latency:	7 ms typical
Byte Length:	10 or 11 bits
Maximum Data Transmission:	Continuous up to 115200 bps

## RF CHARACTERISTICS (TNC RF Connector)

---

### TRANSMITTER:

Power Output (at antenna connector):	0.1 to 1.0 Watt (+20 dBm to +30 dBm), <i>set by user</i>
Duty Cycle:	Continuous
Modulation Type:	Binary CPFSK
Output Impedance:	50 Ohms
Spurious:	-49 dBm, 216 MHz–960 MHz -41 dBm above 960 MHz

### RECEIVER:

Type:	Double-conversion superheterodyne
Sensitivity:	-110 dBm @ $10^{-6}$ BER
Intermodulation:	54 dB minimum (EIA)
Desensitization:	75 dB
Spurious:	70 dB minimum
Bandwidth:	200 kHz
Interference Ratio (SINAD degraded by 3dB):	Co-channel: -10 dB Adjacent channel: +30 dB Two channels away: +40 dB Three channels away: +48 dB
Time Required to Synchronize with Master Radio:	0.5 seconds (typical)

## 10.2 Product Specifications—2.4 GHz

### GENERAL

---

Frequency Band:	2401.6–2477.8 MHz ISM band A: 2401.6 MHz–2427.0 MHz B: 2427.2 MHz–2452.6 MHz C: 2452.8 MHz–2478.2 MHz Subdivided into eight 3.2 MHz zones.
Hop Pattern:	Based on network address
Frequency Stability:	$\pm 1.5$ ppm
Half-Duplex Operation:	$\pm 1.6$ MHz TX/RX split
Network Addresses:	65,000
Temperature Range:	-40° C to +70° C
Humidity:	<95% RH at +40° C; non-condensing



Primary Power:	13.8 Vdc, Nominal (6–30 Vdc range)
Current Draw (typical @ 27 dBm):	
Transmit:	510 mA @ 13.8 Vdc
Receive:	100 mA @ 13.8 Vdc
Sleep Mode (typical):	≤ 3 mA @ 13.8 Vdc
Size:	5.30" W x 3.50" D x 1.40"H (135 W x 89 D x 36 H mm). Weight: 1 Lb/0.5 k w/o brackets; 1.15 Lb / 0.52 k w/brackets
Weight:	1 Lb / 0.5 k w/o brackets; 1.15 Lb / 0.52 k w/brackets
Case:	Die-cast aluminum
Agency Approvals:	<ul style="list-style-type: none"> <li>• FCC Part 15 <i>Pending</i> (E5MDS-EL805-24)</li> <li>• IC: Approved</li> <li>• Contact the factory for information on governmental approvals for other countries</li> </ul>
MTBF (reliability):	Consult factory for on-file data

## DATA CHARACTERISTICS (DB-9 Data Port)

---

Data Interface:	RS-232/422/485
Interface Connector:	DB-9 female
Data Rate:	300, 600, 1200, 1800, 2400, 4800, 9600, 19200, 38400, 57600, 115200 bps asyn- chronous
Data Latency:	7 ms typical
Byte Length:	10 or 11 bits
Maximum Data Transmission:	Continuous up to 115200 bps

## RF CHARACTERISTICS (TNC RF Connector)

---

### TRANSMITTER:

Power Output (at antenna connector):	0.1 to 0.5 watt (+20 dBm to +27 dBm), <i>set by user</i>
Duty Cycle:	Continuous
Modulation Type:	Binary CPFSK
Output Impedance:	50 Ohms
Spurious:	–49 dBm, 216 MHz–960 MHz –41 dBm above 960 MHz

### RECEIVER:

Type:	Double-conversion superheterodyne
Sensitivity:	–108 dBm @ 10 <sup>–6</sup> BER
Intermodulation:	54 dB minimum (EIA)
Desensitization:	75 dB
Spurious:	70 dB minimum
Bandwidth:	200 kHz



## 10.3 Diagnostic Interface Connections (RJ-11)

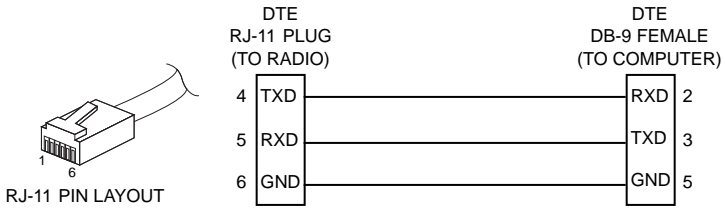

**Figure 21. RJ-11 to DB-9 Adapter Cable—Wiring Details**

**NOTE:** Only wire pins 4, 5, and 6. Pins 1, 2, and 3 are reserved for special functions and are not normally connected.

## 10.4 Data Interface Connections (DB-9F)

The DATA connector ([Figure 22](#)) is used to connect the radio to an external DTE data terminal that supports the EIA/RS-232 or EIA/RS-485 (balanced) format, depending on how the radio was configured at the factory. The radio supports data rates of 300, 600, 1200, 1800, 2400, 4800, 9600, 19200, 38400, 57600, and 115200 bps (asynchronous data only).

The DATA connector mates with a standard DB-9 plug that is available from many electronics parts distributors. [Table 27](#) and [Table 28](#) provide detailed pin descriptions for the DATA connector in RS/EIA-232 mode and RS/EIA-485 mode, respectively. Pin Descriptions—RS/EIA-232 Mode

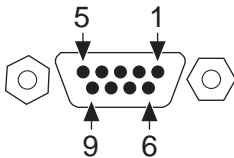

**Figure 22. DATA Connector (DB-9F)**  
As viewed from outside the radio



## Pin Descriptions—RS/EIA-232 Mode

Table 27 lists the DATA connector pin functions for radios configured to operate in RS/EIA-232 mode.

**NOTE:** The radio is hard-wired as a DCE in the EIA-232 mode.

**Table 27. DATA connector pin descriptions—RS/EIA-232**

Pin Number	Input/Output	Pin Description
1	OUT	DCD (Data Carrier Detect) A “high” indicates hopping synchronization.
2	OUT	RXD (Received Data) Supplies received data to the connected device.
3	IN	TXD (Transmitted Data) Accepts TX data from the connected device.
4	IN	Sleep—A ground on this pin turns off most circuits in a Remote radio, including transmit, receive, modem, and diagnostic functions. This allows for greatly reduced power consumption, yet preserves the radio’s ability to be quickly brought on line. See <a href="#">“Using the Radio’s Sleep Mode (Remote Units Only)”</a> on Page 59 for details.
5	IN	Signal Ground— Connects to ground (negative supply potential) on the radio’s PC board and chassis.
6	OUT	Alarm Output—An RS-232 high/space (+5.0 Vdc) on this pin indicates an alarm condition. An RS-232 low/mark (–5.0 Vdc) indicates normal operation. This pin may be used as an alarm output. (See <b>ASENSE [HI/LO]</b> <a href="#">Details, Page 29</a> for further information.)
7	IN	RTS (Request-to-Send)
8	OUT	CTS (Clear-to-Send)—Goes “high” after the programmed CTS delay time has elapsed (DCE), or keys an attached radio when RF data arrives (CTS KEY).
9	--	Reserved for Special Uses (Do not connect)

## Pin Descriptions—RS/EIA-422/485 Mode

Table 28 lists the DATA connector pin functions for radios configured to operate in RS/EIA-422/485 mode. See Figure 23 for wiring schemes.

**Table 28. DATA connector pin descriptions—RS-422/485 Mode**

Pin Number	Input/Output	Pin Description
1	—	Not Used—Do not connect
2	OUT	TXD+/TXA—Non-inverting driver output. Supplies data to the connected device.
3	IN	RXD+/RXA—Non-inverting receiver input. Accepts data from the connected device.
4	IN	Sleep—A ground on this pin turns off most circuits in a Remote radio, including transmit, receive, modem, and diagnostic functions. This allows for greatly reduced power consumption, yet preserves the radio's ability to be quickly brought on line. See "Using the Radio's Sleep Mode (Remote Units Only)" on Page 59 for details.
5	--	Signal Ground (GND)—Connects to ground (negative supply potential) on the radio's PC board and chassis.
6	--	Not Used—Do not connect
7	IN	RXD- /RXB—Inverting receiving input
8	OUT	TXD- /TXB—Inverting driver output.
9	--	Open (User configurable via internal jumper. See "User Configurable I/O Connections" on Page 73)

### NOTES:

- RXD+ / RXB and RXD- / RXA are data sent to the radio to be transmitted.
- RXD+ / RXB is positive with respect to RXD- / RXA when the line input is a "0".
- TXD+ / TXB and TXD- / TXA are data received by the radio and transmitted.
- TXD+ / TXB is positive with respect to the TXD- / TXA when the line output is a "0".

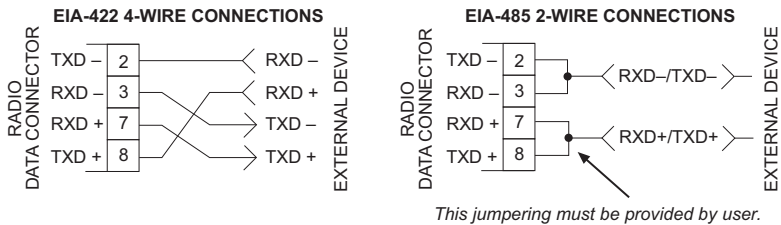

**Figure 23. EIA-422/485 Wiring Schemes**



## 10.5 Board-Only Supplemental Data

The TransNET 900 board-only radio is electrically and operationally similar to the standard (metal enclosed) version described in the body of this manual. Refer to this manual for connector assignments, software commands and other product information. This supplementary data explains the items that are unique to the board-only radio.



Figure 24. MDS TransNET 900 Board-Only Transceiver

### Product Differences—Board-only vs. Standard

The main differences between the board-only unit and the standard version are physical—including overall dimensions and mounting hole spacing. In addition, the board-only unit's LED panel is positioned differently than on the standard unit. The LED order and functionality remain the same, however.

Finally, the board-only unit is not intended for high duty cycle applications such as may be required in some master station and repeater arrangements (see note below). This is due to heat dissipation requirements.

#### NOTE

The board-only unit is not suitable for extremely high duty cycle applications. For master station or repeater use, where transmit duty cycles could approach 50%, it is recommended that a standard (metal enclosed) TransNET be utilized.

### Unit Dimensions

The TransNET board-only radio is designed to fit into restricted spaces, and is considerably smaller than the metal enclosed version. The dimensions of the unit (excluding connectors) are as follows:

Height: 0.906 in. (2.3 cm)  
Width: 5.063 in. (12.9 cm)  
Depth: 3.563 in. (9.1 cm)

**CAUTION:** The bottom of the board-only radio is **not** insulated. When mounting the unit, ensure that no protruding objects will contact the bottom of the circuit board.

## Mounting Requirements

The radio may be mounted to any flat surface using four sheet metal screws, machine screws or other suitable fasteners. Fasteners are not supplied with the radio. The radio should be mounted in a manner that permits easy access to the connectors and viewing of the status LEDs.

Figure 2 shows the mounting hole spacing for the board-only radio. To prepare the mounting surface for drilling, it may be helpful to use the radio case itself as a template. To do this, position the radio as desired and mark through the mounting holes with a felt-tip pen or similar marking instrument.

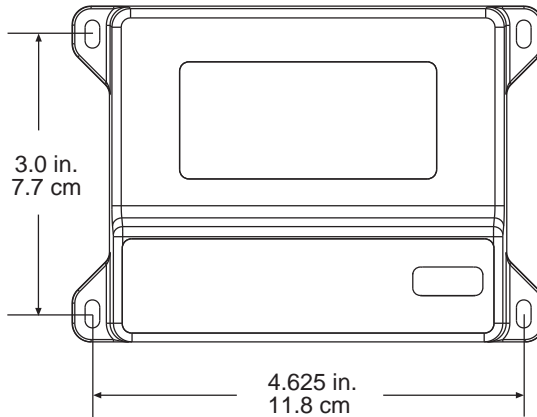

**Figure 25. Mounting Hole Dimensions**

## 10.6 User Configurable I/O Connections

Several connection points (eyelets) are provided within the transceiver near the DATA interface connector that allow the user to facilitate unique integration requirements.

By jumpering eyelets, external functions (unconditioned I/O) may be communicated within the TransNET network using a Network Management System (NMS) such as InSite or a user's custom application that uses the Network-Wide Diagnostics Protocol. Specifications for this protocol are open and are contained within the InSite distribution material on CD and on the GE MDS Web site.

One pin of the DB-9 Data Interface connector supports this function, as well as three pins of the RJ-11 Diagnostics connector. See Tables 27 and 28 on the previous pages for details.

**CAUTION**  
**POTENTIAL**  
**EQUIPMENT**  
**DAMAGE**

Care should be taken when soldering to the PCB eyelets due to their small size. For this reason, only qualified personnel should install the jumpers and external connections.

Installation of internal jumpers and connection to non-standard interface pins may void the product's warranty.

If you are uncertain of your interface design, please consult with the factory Technical Services Department for a review of your design to assure maintenance of your warranty.

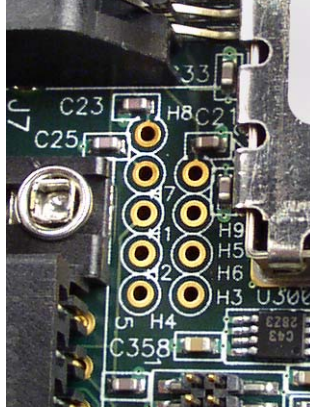

**Figure 26. User Interface I/O Jumper Eyelets**  
*PCBs 03-4040A03/A04 and later*

**NOTE:** If your PCB does not look like the one in the [Figure 26](#), consult with the factory Technical Services for assistance.

Each pin connected to user-designed equipment must be connected through a special cable constructed to breakout the User I/O pins.

Your interface can complement your unique requirements. The input signals and output interface must be within the radio's interface parameters as summarized in [Table 29](#).

**Table 29. TransNET User I/O Connection Resources**

Function or Service	Range	Available at eyelet:
Filtered Receive Audio (For test purposes)	0 – 5 Vac, 30–5 kHz	H2
General Purpose I/O 1 (GPIO 1) <sup>a</sup>	TTL; External 10K to 3.3 V Vcc Recommended	H3
General Purpose I/O 2 (GPIO 2) <sup>b</sup>	TTL; External 10K to 3.3 V Vcc Recommended	H4
Analog 1 <sup>c</sup>	0 – 5 Vac, ≤ 60 HZ	H6
<i>Do not connect. Factory use only.</i>		H5

**Table 29. TransNET User I/O Connection Resources**

Data Interface Pin	Available at eyelet:
DB-9, Pin 9	H1
RJ-11, Pin 1	H7
RJ-11, Pin 2	H8
RJ-11, Pin 3	H9

- a. Configuration and data retrievable via MDS InSite™ software as “I/O 1”
- b. Configuration and data retrievable via MDS InSite™ software as “I/O 2”
- c. Parameter retrievable via MDS InSite™ software

### Using the I/O Points with InSite™ NMS Software

InSite software has the ability to read the user analog input (**Analog 1**) and two user-configurable and independent I/O signals (**I/O 1 & I/O 2**). Each I/O connection can independently be configured as input or output. If configured as an output, a *saved* default output value can be stored in the radio to ensure the radio boots to the desired state for this pin.

The values of **I/O 1 & I/O 2** can be read and displayed by an InSite user to determine the current state. The values of **I/O 1 & I/O 2** at the TransNET’s DATA Interface connector will remain in a constant state until manually changed through the InSite **Configuration** screen.

### Application Example—Digital Input and Output at a Remote

A typical application of the user I/O connections may require one digital input and one digital output to be controlled by network diagnostics. In this example, H3 could be jumpered to H7 (I/O 1 to RJ-11, Pin 1) and H4 jumpered to H8 (I/O 2 to RJ-11, Pin 2). Using InSite, **I/O 1** could be configured as an output and **I/O 2** as an input.



## 10.7 dBm-Watts-Volts Conversion Chart

Table 30 is provided as a convenience for determining the equivalent voltage or wattage of an RF power expressed in dBm with 50 Ohms load.

**Table 30. dBm-Watts-Volts Conversion Chart**

<b>dBm</b>	<b>V</b>	<b>Po</b>	<b>dBm</b>	<b>V</b>	<b>Po</b>	<b>dBm</b>	<b>mV</b>	<b>Po</b>	<b>dBm</b>	<b>μV</b>	<b>Po</b>
+53	100.0	200W	0	.225	1.0mW	-49	0.80		-98	2.9	
+50	70.7	100W	-1	.200	.80mW	-50	0.71	.01μW	-99	2.51	
+49	64.0	80W	-2	.180	.64mW	-51	0.64		-100	2.25	.1pW
+48	58.0	64W	-3	.160	.50mW	-52	0.57		-101	2.0	
+47	50.0	50W	-4	.141	.40mW	-53	0.50		-102	1.8	
+46	44.5	40W	-5	.125	.32mW	-54	0.45		-103	1.6	
+45	40.0	32W	-6	.115	.25mW	-55	0.40		-104	1.41	
+44	32.5	25W	-7	.100	.20mW	-56	0.351		-105	1.27	
+43	32.0	20W	-8	.090	.16mW	-57	0.32		-106	1.18	
+42	28.0	16W	-9	.080	.125mW	-58	0.286				
+41	26.2	12.5W	-10	.071	.10mW	-59	0.251				
+40	22.5	10W	-11	.064		-60	0.225	.001μW	<b>dBm</b>	<b>nV</b>	<b>Po</b>
+39	20.0	8W	-12	.058		-61	0.200		-107	1000	
+38	18.0	6.4W	-13	.050		-62	0.180		-108	900	
+37	16.0	5W	-14	.045		-63	0.160		-109	800	
+36	14.1	4W	-15	.040		-64	0.141		-110	710	.01pW
+35	12.5	3.2W	-16	.0355					-111	640	
+34	11.5	2.5W				<b>dBm</b>	<b>μV</b>	<b>Po</b>	-112	580	
+33	10.0	2W	<b>dBm</b>	<b>mV</b>	<b>Po</b>	-65	128		-113	500	
+32	9.0	1.6W	-17	31.5		-66	115		-114	450	
+31	8.0	1.25W	-18	28.5		-67	100		-115	400	
+30	7.10	1.0W	-19	25.1		-68	90		-116	355	
+29	6.40	800mW	-20	22.5	.01mW	-69	80		-117	325	
+28	5.80	640mW	-21	20.0		-70	71	.1nW	-118	285	
+27	5.00	500mW	-22	17.9		-71	65		-119	251	
+26	4.45	400mW	-23	15.9		-72	58		-120	225	
+25	4.00	320mW	-24	14.1		-73	50		.001pW		
+24	3.55	250mW	-25	12.8		-74	45		-121	200	
+23	3.20	200mW	-26	11.5		-75	40		-122	180	
+22	2.80	160mW	-27	10.0		-76	35		-123	160	
+21	2.52	125mW	-28	8.9		-77	32		-124	141	
+20	2.25	100mW	-29	8.0		-78	29		-125	128	
+19	2.00	80mW	-30	7.1	.001mW	-79	25		-126	117	
+18	1.80	64mW	-31	6.25		-80	22.5	.01nW	-127	100	
+17	1.60	50mW	-32	5.8		-81	20.0		-128	90	
+16	1.41	40mW	-33	5.0		-82	18.0		-129	80	.1fW
+15	1.25	32mW	-34	4.5		-83	16.0		-130	71	
+14	1.15	25mW	-35	4.0		-84	11.1		-131	61	
+13	1.00	20mW	-36	3.5		-85	12.9		-132	58	
+12	.90	16mW	-37	3.2		-86	11.5		-133	50	
+11	.80	12.5mW	-38	2.85		-87	10.0		-134	45	
+10	.71	10mW	-39	2.5		-88	9.0		-135	40	
+9	.64	8mW	-40	2.25	.1μW	-89	8.0		-136	35	
+8	.58	6.4mW	-41	2.0		-90	7.1	.001nW	-137	33	
+7	.500	5mW	-42	1.8		-91	6.1		-138	29	
+6	.445	4mW	-43	1.6		-92	5.75		-139	25	
+5	.400	3.2mW	-44	1.4		-93	5.0		-140	23	.01fW
+4	.355	2.5mW	-45	1.25		-94	4.5				
+3	.320	2.0mW	-46	1.18		-95	4.0				
+2	.280	1.6mW	-47	1.00		-96	3.51				
+1	.252	1.25mW	-48	0.90		-97	3.2				





## INDEX

### A

- Accessories (table) 5
- ADDR command (set/display radio network address) 29
- Alarm
  - checking for 46
  - code definitions 47
  - codes 46
  - codes, table 47
  - major vs. minor 46
  - receiver timeout (RXTOT command) 40
  - reset output signal 29
  - set/display output sense (ASENSE command) 29
  - status (STAT command) 43
- ALARM command (superseded; see STAT command) 43
- Alarm Mask (AMASK) Command 29
- Alarm Sense (ASENSE) Command 29
- Alarm Status Command (STAT) 43
- AMASK command (configure alarm output signal) 29
- Antenna
  - installation 15
  - performance optimization 20
  - selection 9
  - SWR check 21
  - system gain vs. power output setting, table 13
  - Yagi, illustrated 10
- ASENSE command (set/display alarm output sense) 29

### B

- BAUD command (set/display data interface port attributes) 29
- Baud rate
  - setting 22
  - setting for RJ-11 DIAG port (DLINK command) 49
- BUFF command (set/display received data handling mode) 30

### C

- Cable
  - data equipment to DATA INTERFACE connector 15, 22
  - data interface wiring for tail-end links 19
  - feedlines 10
  - maximum length, recommended 16, 71
- Clear Zone Statistics Log, ZONE CLEAR 44
- Clear-to-Send Delay (CTS) Command 31
- Clear-to-Send Hold Time (CTSHOLD) Command 32
- Clock-Synchronizing Master Address (CSADDR) Command 31
- CODE command (display/set encryption value) 31
- Command 36
  - TEMP (radio's internal temperature reading) 43
- Commands



ADDR (set/display radio network address) 29  
AMASK (configure alarm output signal) 29  
ASENSE (set/display alarm output sense) 29  
BAUD (set/display data interface port attributes) 29  
BUFF (set/display received data handling mode) 30  
CODE (set/display encryption value), See also Encryption 31  
CTS (set/display CTS line response timer) 31  
CTSHOLD (set/display CTS hold timer) 32  
detailed descriptions 28–44  
DEVICE (set/display DCE or CTS Key behavior) 32  
display operating status 24  
DKEY Command, Turn off radio transmitter test signal 33  
DTYPE (set radio's diagnostics type) 33  
FEC (Forward Error Correction) 33  
FEC (Forward Error Correction) Command 33  
HOPTIME (set/display hoptime setting) 34  
how used 28  
INIT (restore factory default settings) 34  
LPM (low-power mode) 36  
LPMHOLD (low-power mode sleep time) 36  
MODE (display/set radio mode as master, remote, or extension) 36  
MODE (radio operating mode) 36  
most often used commands 28  
network configuration 23  
OWM (set/display optional owner's message) 37  
OWN (set/display optional owner's name) 37  
PORT (display/set current data port) 37  
PWR (set/display RF forward output power) 38  
Radio transmitter test frequency (TX) 43  
RSSI (display received signal strength) 38  
RTU (enable/disable internal RTU) 39  
RX (set/display receiver test frequency) 39  
RXD 39  
RXTOT (set/display received data timeout value) 40  
SAF (store-and-forward) 40  
SER (radio serial number) 40  
SETUP (enter testing and setup mode) 40  
SHOW (display measured power output) 41  
SHOW PWR (show power) 41  
SHOW SYNC 41  
SHOW SYNC (show Clock-Synchronization Master) 41  
SKIP (set/display frequency zone to skip) 41  
SLEEP (display/set radio's sleep mode setting) 42  
SLEEP (transceiver sleep mode) 42  
SREV (firmware/software revision level) 42  
STAT (list alarms) 43  
TEMP (display internal temperature) 43  
UNIT (unit address) 43  
XADDR (extended address) 44  
XMAP (Map of Extension Addresses) 44



- XPRI (display/program primary radio's extended address) 44
- XRSSI (sets min. signal level for sync. with non-primary extension unit) 44
- Connectors
  - Diagnostic Interface, Connections 69

## D

- Data Baud Rate (BAUD) Command 29
- Data Baud Rate (BUFF) Command 30
- Data buffer setting 21, 30
- DATA INTERFACE
  - cable wiring for tail-end links, illustrated 19
  - connections 69
  - connector pin descriptions, table 70
- Data Port Signalling Standard (PORT) Command 37
- Default settings
  - data interface baud rate 22
  - factory settings reset by INIT command (table) 34
  - restoring (INIT command) 34
  - See also individual command descriptions*
- DEVICE Command 32
- DEVICE command (set/display DCE or CTS Key behavior) 32
- Diagnostics
  - network-wide, performing 49
  - setup mode (SETUP command) 40
  - using InSite software for network-wide 49
- Diagnostics Link (DLINK) 32
- Display
  - alarm output sense (ASENSE command) 29
  - alarms (STAT command) 43
  - CTS hold timer value (CTSHOLD command) 32
  - CTS line response timer value (CTS command) 31
  - data interface baud rate (BAUD command) 29
  - device behavior (DEVICE command) 32
  - hoptime setting (HOPTIME command) 34
  - network address (ADDR command) 29
  - operating status commands 24
  - owner's message (OWM command) 37
  - owner's name (OWN command) 37
  - receive test frequency (RX command) 39
  - received data handling mode (BUFF command) 30
  - received data timeout value (RXTOT command) 40
  - received signal strength (RSSI command) 38
  - RF forward output power (PWR command) 38
  - RF power output, actual measured (SHOW command) 41
  - skipped frequency zones (SKIP command) 41
  - temperature, internal (TEMP command) 43
- display/set radio mode as master, remote, or extension (see MODE command) 36
- DKEY command (disable transmitter) 21, 40
- DKEY, Disable Transmitter, Command 33
- DLINK command (set/display baud rate of diagnostics link) 49

Downstream Repeat Transmission Count (REPEAT) Command 38  
DSP (digital signal processing) 1, 47  
DTYPE command (set radio's diagnostics type) 33, 49, 50

## E

Enable  
    internal RTU (RTU command) 39  
    network-wide diagnostics, procedures 49  
    Setup mode (SETUP command) 40  
    skipped zone (SKIP command) 41  
    Sleep Mode  
Enable/Disable LEDs (LED) Command 36  
Encryption. See CODE command  
Equipment List 33  
Extended Address Command (XADDR) 44  
Extension radio. See Store-and-Forward (SAF)

## F

Feedline  
    selection 9, 10  
Firmware Revision Level Command (SREV) 42  
Forward-Error Correction (FEC) Command 33  
Fuse Replacement 50

## G

Gate (radio diagnostics type) 33, 50

## H

Hardware Revision (HREV) Command 35  
Hayes-Compatible AT Command (AT) 29  
Hoptime  
    setting 21  
HOPTIME Command (radio transmitter hop timing) 34  
HOPTIME command (set/display hoptime setting) 34

## I

Illustrations  
    antenna, Yagi 10  
    data interface cable wiring for tail-end links 19  
    model configuration code 74  
    point-to-point link 3  
    remote station arrangement 6  
    tail-end link 4  
    typical MAS network 3  
INIT command (restore factory default settings) 34  
Initialize 34  
InSite software 49  
Installation  
    antenna 15  
    connecting transceiver to data equipment 15, 22



- feedline selection 10
- performance optimization 20
- requirements 6
- site selection 6
- site survey 7
- tail-end links 18
- transmission path 7

Interference

- about 8
- checks 22
- troubleshooting 48

interference 8

## **K**

### Key

- set to CTS keying (DEVICE command) 32
- transmitter, for antenna SWR check 21

KEY command (key transmitter) 21, 40

## **L**

### LED status indicators

- table 20, 46

Low-Power Mode (LPM) Command 36

Low-Power Mode Sleep Time (LPMHOLD) Command 36

LPM Command (low-power mode) 36

LPMHOLD Command 36

## **M**

Map 44

Map of Extension Addressses (XMAP) 44

### Master Station

- default settings 34

MIRRORED BITS™ Protocol Support 62, 63

MODE Command 36

MODE command (display/set radio mode as master, remote, or extension) 36

MODE command (display/set radio's operating mode as master, remote, or extension) 36, 37

Model configuration code, illustrated 74

### Modes

- Low-Power Mode versus Remote's Sleep 62

Mounting instructions/dimensions 14–15

### Multiple Address System (MAS)

- network, illustrated 3

Multiple Address Systems (MAS) 2

## **N**

Network Address (ADDR) Command 29

Network configuration commands 23

Network Diagnostics Mode (DTYPE) Command 33

Network-wide diagnostics

procedures 49

Node (radio diagnostics type) 33, 50

## O

LED 36

Modbus, BUFF 30

Operation 19–22

OWM command (set/display optional owner's message) 37

OWN command (set/display optional owner's name) 37

Owner's Message (OWM) Command 37

Owner's Name Command (OWN) 37

## P

PC

connecting to radio's diagnostic port 49

launching InSite application at 49

performing diagnostics using connected 49

Peer (radio diagnostics type) 33, 50

Performance optimization 20

Pins, DATA INTERFACE connector descriptions (table) 70

Point-to-point system

link, illustrated 3

Point-to-Point System (P-P) 3

PORT command (set/display current data port) 37

Power

Low-Power Mode versus Remote's Sleep 62

Power (RF)

how much can be used 11

Measurement 41

set/display RF forward output (PWR command) 38

Power saving mode (see Sleep Mode)

Primary Extension Address (XPRI) 44

Procedures

antenna aiming 20

antenna and feedline selection 9

antenna SWR check 21

connecting data equipment to DATA INTERFACE connector 15, 22

connecting PC and radios for network-wide diagnostics 49

enabling sleep mode

installation planning 6

installing the antenna and feedline 15

interference check 22

mounting the transceiver 14–15

network-wide diagnostics 49

performance optimization 20

performing network-wide diagnostics 49

programming radio for network-wide diagnostics 49

reading LED status indicators 19

site selection 6

troubleshooting 45–48



Programming radio 28–44  
  as root or node 49  
PWR command (set/display RF forward output power) 38

## R

### Radio

- inoperative (troubleshooting chart) 48
- no synchronization with master (troubleshooting chart) 48
- poor performance (troubleshooting chart) 48
- Radio Operating Mode (MODE) Command 36, 37
- Radio Receive Test Frequency Command (RX) 39
- Radio Serial Number Command (SER) 40
- Radio Transmit Test Frequency (TX) 43
- Radio Transmitter Hop Timing (HOPTIME) 34
- Radio Transmitter Power Level (PWR) Command 38
- Radio's Internal Temperature Command (TEMP) 43
- Radio-MODEM Behavior (DEVICE) Command 32
- Receive Data Timeout-Timer Command (RXTOT) 40
- Received Signal Strength Indicator Command (RSSI) 38
- Remote radio
  - default settings 34
- Remote station
  - typical arrangement, illustrated 6
- Remote Terminal Unit Simulator Command (RTU) 39
- Repeater Operation. See Store-and-Forward (SAF)
- Restore to Factory Defaults (INIT) 34
- RJ-11
  - Diagnostic Interface, Connection 69
- Root (radio diagnostics type) 33, 50
- RSSI command (display received signal strength) 38
- RTU command (enable/disable internal RTU) 39
- RX command (set/display test receive frequency) 39
- RXD Command 39
- RXD Delay Command (RXD) 39
- RXTOT command (set/display received data timeout value) 40

## S

SAF command (store-and-forward) 40

### Security

- Network Address 65
- optional encryption value 65
- Security Code (CODE) Command 31
- Security, Data 65
- SER Command 40

### Set

- alarm output sense (ASENSE command) 29
- alarm output signal (AMASK command) 29
- CTS hold timer (CTSHOLD command) 32
- CTS line response timer (CTS command) 31
- data interface baud rate (BAUD command) 29



- DCE or CTS Key device behavior (DEVICE command) 32
- frequency zone to skip (SKIP command) 41
- hoptime (HOPTIME command) 34
- network address (ADDR command) 29
- owner's message (OWM command) 37
- owner's name (OWN command) 37
- radio mode (see MODE command) 36
- received data handling mode (BUFF command) 30
- received data timeout value (RXTOT command) 40
- receiver test frequency (RX command) 39
- testing mode (SETUP command) 40
- SETUP command (enter testing and setup mode) 40
- Setup Radio Test (SETUP) 40
- Show Clock-Synchronization Master Network Address (SHOW SYNC) 41
- SHOW command (display power output) 41
- SHOW CON Command (show virtual connection status) 41
- Show Measured RF Transmit Power (SHOW PWR) 41
- SHOW SYNC Command 41
- Show Virtual Connection Status Command (SHOW CON) 41
- Site selection 6
- SKIP command (set/display frequency zone to skip) 41
- Skip Radio Operating Zones (SKIP) 41
- SLEEP command (display/set radio's sleep setting) 42
- SLEEP command (transceiver sleep ON/OFF) 42
- Sleep Mode 59
- Spread spectrum, basic principles of 2
- SREV Command 42
- STAT command (list alarms) 43
- Store-and-Forward (SAF) 4, 23, 27, 34, 40, 45, 52, 57
- Store-and-Forward Services (SAF) Support Command 40
- SWR (Standing Wave Ratio)
  - performance optimization 21
- Synchronization qualifiers 46, 55
- synchronization, check 8

## T

### Tables

- accessories 5
- alarm codes 47
- antenna system gain vs. power output setting 13
- DATA INTERFACE connector pin descriptions 70
- LED status indicators 20, 46
- troubleshooting 48

Tail-end link

- Adding to Existing Network 3
- cable wiring for, illustrated 19
- illustrated 4
- installation 18

Technical specifications 66–68

TEMP command (display internal temperature) 43





- Temperature, display internal (TEMP command) 43
- Terrain 7
- Terrain and Signal Strength 7
- Test, on-the-air 7
- Transceiver
  - connecting to data equipment 15, 22
  - default settings 34
  - mounting instructions/dimensions 14–15
  - performance optimization 20
  - sleep mode 59
- Transceiver Sleep (SLEEP) 42
- Troubleshooting 45–48
  - performing network-wide diagnostics 49
  - table 48
- Turn Off Radio Transmitter Test Signal (DKEY) Command 33
- Turn On Radio Transmitter Test Signal (KEY) Command 35

## U

- UNIT Command (unit address) 43
- Upstream Repeat Transmission Count Command (RETRY) 38

## X

- XADDR (extended address command) 17, 27, 34, 35, 45, 55, 58
- XADDR (extended address) Command 37
- XPRI command (display/set extended address) 44
- XRSSI command (sets min. RSSI level to maintain sync. w/non-primary extension radio) 44

## Z

- ZONE CLEAR (clear zone statistics log) 44
- ZONE DATA Command (read zone statistics log) 44
- Zone, Clear Statistics Log (ZONE CLEAR) 44
- Zone, Read Statistics Log (ZONE DATA) 44



## ***IN CASE OF DIFFICULTY...***

---

GE MDS products are designed for long life and trouble-free operation. However, this equipment, as with all electronic equipment, may have an occasional component failure. The following information will assist you in the event that servicing becomes necessary.

## **TECHNICAL ASSISTANCE**

---

Technical assistance for GE MDS products is available from our Technical Support Department during business hours (8:30 A.M.–6:00 P.M. Eastern Time). When calling, please give the complete model number of the radio, along with a description of the trouble/symptom(s) that you are experiencing. In many cases, problems can be resolved over the telephone, without the need for returning the unit to the factory. Please use one of the following means for product assistance:

Phone: 585 241-5510

E-Mail: [gemds.techsupport@ge.com](mailto:gemds.techsupport@ge.com)

FAX: 585 242-8369

Web: [www.gemds.com](http://www.gemds.com)

## **FACTORY SERVICE**

---

Component level repair of equipment is not recommended in the field. Many components are installed using surface mount technology, which requires specialized training and equipment for proper servicing. For this reason, the equipment should be returned to the factory for any PC board repairs. The factory is best equipped to diagnose, repair and align your unit to its proper operating specifications.

If return of the equipment is necessary, you will be issued a Service Request Order (SRO) number. The SRO number will help expedite the repair so that the equipment can be repaired and returned to you as quickly as possible. Please be sure to include the SRO number on the outside of the shipping box, and on any correspondence relating to the repair. No equipment will be accepted for repair without an SRO number.

A statement should accompany the unit describing, in detail, the trouble symptom(s), and a description of any associated equipment normally connected to it. It is also important to include the name and telephone number of a person in your organization who can be contacted if additional information is required. *Note: A backup copy of the product's programming code should be retained (if applicable), as units are normally returned from the factory in a default state.*

The unit must be properly packed for return to the factory. The original shipping container and packaging materials should be used whenever possible. All factory returns should be addressed to:

GE MDS, LLC  
Product Services Department  
(SRO No. XXXX)  
175 Science Parkway, Rochester, NY 14620 USA

When repairs have been completed, the equipment will be returned to you by the same shipping method used to send it to the factory. Please specify if you wish to make different shipping arrangements. To inquire about an in-process repair, you may contact our Product Services Group using the telephone, Fax, or E-mail information given above.



Digital Energy  
MDS

GE MDS, LLC  
175 Science Parkway  
Rochester, NY 14620  
General Business: +1 585 242-9600  
FAX: +1 585 242-9620  
Web: [www.gemds.com](http://www.gemds.com)

